

Mimio®  
Interactive Teaching Technologies

# MimioClassroom User Guide for Windows®



[mimio.dymo.com](http://mimio.dymo.com)

© 2011 Sanford, L.P. All rights reserved. Revised 12/12/2011.

No part of this document or the software may be reproduced or transmitted in any form or by any means or translated into another language without the prior written consent of Sanford, L.P.

Mimio, MimioClassroom, MimioTeach, MimioCapture, MimioVote, MimioView, MimioHub, and MimioStudio are registered marks in the United States and other countries. All other trademarks are the property of their respective holders.

---

# Contents

---

<b>About MimioClassroom</b> .....	1
MimioStudio.....	1
MimioTeach.....	1
Mimio Interactive.....	1
MimioCapture.....	2
Mimio Capture Kit.....	2
MimioVote.....	2
MimioView.....	2
Mimio Pad.....	2
Minimum System Requirements.....	2
Using this Guide.....	3
<b>MimioStudio</b> .....	7
About MimioStudio.....	7
About MimioStudio Notebook.....	7
About MimioStudio Tools.....	7
About MimioStudio Gallery.....	9
Getting Started with MimioStudio.....	9
Accessing MimioStudio Notebook.....	9
Accessing MimioStudio Tools.....	10
Accessing MimioStudio Gallery.....	10
Using MimioStudio Notebook.....	10
Working with Pages.....	11
Creating an Activity.....	14
Creating an Activity - Step 1: Define.....	14
Creating an Activity - Step 2: Select.....	14
Creating an Activity - Step 3: Refine.....	15
Creating an Activity - Step 4: Review.....	16
Writing an Objective.....	17
Attaching Files.....	17
Using MimioStudio Tools.....	18
Creating Objects.....	18
Manipulating Objects.....	21
Adding Actions to Objects.....	24
Using MimioStudio Gallery.....	26
Importing Gallery Items into a Notebook.....	27

---

Customizing the Content of the Gallery.....	27
Exporting a Gallery Folder to a Gallery File.....	28
Working with Saved Annotation Snapshots.....	28
Viewing Screen Annotation Snapshots.....	29
Renaming an Annotation Snapshot.....	29
Adding Keywords to an Annotation Snapshot.....	29
Searching for an Annotation Snapshot.....	29
Importing an Annotation Snapshot.....	30
Pasting an Annotation Snapshot Into Another Application.....	30
Printing Annotation Snapshots.....	30
Deleting Annotation Snapshots.....	30
Delivering Interactive Notebook Lessons and Presentations.....	30
Using Fullscreen View.....	31
Navigating Through a Presentation.....	31
Working with Multimedia Objects.....	31
<b>MimioTeach</b> .....	33
What's Included.....	33
About MimioTeach.....	33
Status Lights.....	34
About MimioStudio Tools.....	35
Getting Started.....	37
Setting Up the MimioTeach Stylus.....	37
Setting Up the MimioTeach Bar.....	37
Setting Up Interactive Mode.....	39
Projecting Your Desktop.....	39
Calibrating Interactive Mode.....	40
Using MimioTeach.....	40
Using the MimioTeach Stylus.....	41
Focusing Attention Using the Reveal and Spotlight Tools.....	41
Using the Reveal Tool.....	41
Using the Spotlight Tool.....	42
Marking Up the Display Using Screen Annotations.....	43
Enabling Screen Annotation Mode.....	43
Annotating the Screen Using MimioStudio Tools.....	44
Clearing All Annotations from the Display.....	46
Inserting Text Into an Application Using MimioStudio Text Tools.....	47
Using the On-Screen Keyboard.....	47
Using Write Anywhere.....	47

---

Using Writing Pad.....	48
Using Gesture Recognition.....	49
Using the Web Browser, Calculator, and Magnify Tools.....	49
Recording Desktop Actions and Audio in Interactive Mode.....	49
Caring for MimioTeach.....	50
Cleaning MimioTeach.....	50
Inserting the Batteries.....	50
Mounting MimioTeach to a Non-Magnetic Whiteboard.....	50
<b>Mimio Interactive.....</b>	<b>53</b>
What's Included.....	53
About Mimio Interactive.....	53
Status Lights.....	54
About Mimio Wireless.....	55
Status Lights.....	56
About MimioStudio Tools.....	57
Getting Started.....	59
Setting Up the Mimio Interactive Mouse.....	59
Setting Up the Mimio Interactive Bar.....	59
Setting Up Mimio Wireless.....	60
Setting Up Interactive Mode.....	62
Projecting Your Desktop.....	62
Calibrating Interactive Mode.....	63
Using Mimio Interactive.....	64
Using the Mimio Interactive Mouse.....	64
Focusing Attention Using the Reveal and Spotlight Tools.....	64
Using the Reveal Tool.....	64
Using the Spotlight Tool.....	65
Marking Up the Display Using Screen Annotations.....	66
Enabling Screen Annotation Mode.....	66
Annotating the Screen Using MimioStudio Tools.....	67
Clearing All Annotations from the Display.....	69
Inserting Text Into an Application Using MimioStudio Text Tools.....	70
Using the On-Screen Keyboard.....	70
Using Write Anywhere.....	70
Using Writing Pad.....	71
Using Gesture Recognition.....	72
Using the Web Browser, Calculator, and Magnify Tools.....	72
Recording Desktop Actions and Audio in Interactive Mode.....	72

---

---

Caring for Mimio Interactive.....	73
Cleaning Mimio Interactive.....	73
Inserting the Batteries.....	73
Mounting Mimio Interactive Permanently.....	73
<b>MimioCapture.....</b>	<b>77</b>
What's Included.....	77
About MimioCapture.....	77
Status Lights.....	78
About MimioStudio Notebook.....	78
Getting Started.....	78
Setting Up the MimioCapture Tray.....	79
Setting Up the MimioCapture Pens.....	80
Setting Up the MimioCapture Eraser.....	81
Charging the Pens and Eraser.....	82
Setting Up MimioStudio Notebook for Capture.....	82
Setting the Whiteboard Size.....	82
Starting Ink Capture Mode.....	82
Using MimioCapture.....	83
Capturing Digital Ink.....	83
Writing and Drawing Digital Ink.....	83
Adding, Copying, and Printing Notebook Pages.....	84
Caring for MimioCapture.....	84
Cleaning MimioCapture.....	84
Mounting MimioCapture to a Non-Magnetic Whiteboard.....	85
<b>Mimio Capture Kit.....</b>	<b>87</b>
What's Included.....	87
About Mimio Capture Kit.....	87
About MimioStudio Notebook.....	88
Getting Started.....	88
Setting Up the Mimio Capture Kit Pens.....	88
Setting Up the Mimio Capture Kit Eraser.....	90
Setting Up MimioStudio Notebook for Capture.....	91
Setting the Whiteboard Size.....	91
Starting Ink Capture Mode.....	91
Using Mimio Capture Kit.....	92
Capturing Digital Ink.....	92
Writing and Drawing Digital Ink.....	92
Adding, Copying, and Printing Notebook Pages.....	93

---

Downloading Digital Ink.....	94
Caring for Mimio Capture Kit.....	94
Cleaning the Mimio Capture Kit.....	94
Mounting the Mimio Capture Kit.....	95
<b>MimioVote</b> .....	97
What's Included.....	97
About MimioVote.....	97
About the MimioVote Station.....	97
About the MimioVote Units.....	98
About the Software.....	99
About MimioStudio Notebook.....	99
About the Vote Toolbar.....	100
About MimioStudio Quick Vote.....	100
About MimioStudio Gradebook.....	100
Getting Started.....	101
Setting Up MimioVote.....	102
Adding a Second MimioVote System.....	103
Using MimioStudio Gradebook.....	103
Setting Up the Gradebook.....	104
Creating a Class.....	104
Adding Students.....	104
Importing a List of Students.....	104
Adding Activities.....	105
Modifying the Gradebook.....	105
Editing Student Information.....	105
Removing a Student.....	106
Editing Activities.....	106
Editing Questions.....	106
Generating Reports.....	107
Exporting a List of Students.....	107
Archiving Classes.....	107
Exporting Results.....	107
Opening Archived Classes.....	108
Creating MimioVote Activities.....	108
Creating Activities in Notebook.....	109
Creating Activities in PowerPoint®.....	109
Modifying Question Objects.....	110
Importing Standard Assessments.....	110

---

Printing Activities.....	110
Using the MimioVote Unit.....	111
Answering Questions.....	111
Answering Questions for Teacher-Led Activities.....	111
Answering Questions for Self-Paced Activities.....	111
Requesting Help.....	112
Using the Vote Toolbar.....	112
Taking Attendance.....	112
Using the Timer.....	112
Conducting Activities.....	112
Conducting a Teacher-Led Activity.....	113
Asking Questions Using Quick Vote.....	113
Conducting a Self-Paced Activity.....	114
Viewing Question Results.....	114
Viewing Activity Results.....	114
Viewing a List of Students that Have Not Responded.....	115
Viewing Requests for Help.....	115
Caring For MimioVote.....	115
Cleaning MimioVote.....	115
Storing MimioVote.....	116
<b>MimioView</b> .....	117
What's Included.....	117
About MimioView.....	118
Status Lights.....	118
About MimioStudio View.....	119
Getting Started.....	119
Installing MimioView.....	119
Opening the View Window.....	120
Closing the View Window.....	120
Using MimioView.....	120
Displaying an Image.....	120
Displaying a Document.....	120
Displaying an Object.....	121
Displaying a Microscope Slide.....	121
Freezing the Image.....	121
Adjusting the Image.....	122
Rotating the Image.....	122
Zooming the Image.....	122



---

Adjusting the Settings.....	123
Annotating an Image.....	123
Clearing All Annotations from the Image.....	124
Transferring an Image.....	124
Recording Video.....	125
Turning Off the Lamps.....	125
Caring For MimioView.....	125
Cleaning MimioView.....	125
Mounting MimioView Permanently.....	125
<b>Mimio Pad</b> .....	127
What's Included.....	127
About Mimio Pad.....	128
About the Feature Indicators.....	128
Getting Started.....	129
Setting Up the Mimio Pad.....	129
Charging the Battery.....	129
Setting Up the Pen.....	129
Configuring Mimio Pad.....	130
Using Mimio Pad.....	130
Using the Shortcut Keys.....	130
Changing the Pen Tip.....	131
Pairing an Additional Mimio Pad with the Wireless Receiver.....	131
<b>MimioStudio Recorder</b> .....	133
Using MimioStudio Recorder.....	133
Recording a Presentation.....	133
<b>Sharing the Whiteboard Remotely</b> .....	135
Setting up MimioStudio with NetMeeting.....	135
Adjusting the NetMeeting Settings.....	135
<b>Customizing MimioStudio</b> .....	137
Adjusting the Classroom Devices Settings.....	137
Adjusting MimioStudio Gradebook Settings.....	137
Adjusting the Ink Capture Settings.....	138
Adjusting the Interactive Settings.....	140
General Settings.....	140
Actions and Commands Settings.....	140
Adjusting the Language Settings.....	140
Adjusting MimioStudio Notebook Settings.....	141

---

General Settings .....	141
Ink Capture Settings .....	141
Adjusting MimioStudio Recorder Settings .....	142
Adjusting the Vote Settings .....	142
<b>Getting Help</b> .....	143
Updating the Software .....	143
Troubleshooting .....	143
Contacting DYMO .....	143
<b>Technical and Environmental Information</b> .....	145
Environmental Information .....	145
Safety Precautions for Lithium-Ion Rechargeable Batteries .....	145
Documentation Feedback .....	146

# About MimioClassroom

MimioClassroom is a suite of tools for capturing, creating, and presenting information.

The following MimioClassroom components are described in this User Guide:

- MimioStudio
- MimioTeach
- Mimio Interactive
- MimioCapture
- Mimio Capture Kit
- MimioVote
- MimioView
- Mimio Pad

## MimioStudio

---

MimioStudio software includes all of the tools you need to make the most out of your MimioClassroom devices. You can also use the MimioStudio software without a MimioClassroom device to prepare presentations and manipulate previously created content.

MimioStudio Notebook provides a multi-page workspace for creating lessons and presentations. Using the MimioStudio Notebook is very similar to using other word processing or presentation software applications.

MimioStudio Notebook provides multiple authoring and editing tools for creating almost any type of content. You can use Notebook with MimioStudio Tools to create a variety of objects including text boxes, freehand writing and drawing, lines, arrows, and many basic shapes. Images can be imported into a Notebook, both as objects and as background images.

## MimioTeach

---

Using MimioTeach with a projector, you can deliver lessons and presentations directly from your whiteboard. Using MimioStudio Interactive mode, you control the movement of the cursor on your screen with the MimioTeach stylus, much like you would with a mouse at your computer.

## Mimio Interactive

---

Using Mimio Interactive with a projector, you can deliver lessons and presentations directly from your whiteboard. Using MimioStudio Interactive mode, you control the movement of

the cursor on your screen with the Mimio Interactive Mouse, much like you would with a mouse at your computer.

## **MimioCapture**

---

MimioCapture is used with a MimioTeach-enabled whiteboard to record notes and drawings from your whiteboard. Using MimioStudio Ink Capture mode, you make notes and drawings on your whiteboard using the MimioCapture pens. Your notes are automatically captured in a MimioStudio Notebook.

## **Mimio Capture Kit**

---

Mimio Capture Kit is used with a Mimio Interactive-enabled whiteboard to record notes and drawings from your whiteboard. Using MimioStudio Ink Capture mode, you make notes and drawings on your whiteboard using the Mimio Capture Kit pens. Your notes are automatically captured in a MimioStudio Notebook.

## **MimioVote**

---

MimioVote is a wireless, interactive, student response system. Using MimioVote, you can easily and quickly gather student responses. This quick feedback from students allows you to make sure each student is keeping up and adjust your lesson accordingly.

## **MimioView**

---

MimioView works seamlessly with MimioStudio software to display documents, three-dimensional objects, and microscope slides for your entire class to view. You can use MimioView to display still images or live video.

## **Mimio Pad**

---

Mimio Pad is a 2.4 GHz wireless pad. To configure Mimio Pad for use, install the MimioStudio software and plug the wireless receiver into your computer. Once connected, you can use the Mimio Pad from anywhere in the room to interact with your computer. No additional configuration is required.

## **Minimum System Requirements**

---

The minimum system requirements for MimioStudio are:

- Microsoft Windows<sup>®</sup>-compatible computer with a Pentium II, 750 MHz processor
- Microsoft Windows XP SP2, Microsoft Vista<sup>®</sup>, or Microsoft Windows 7 operating system
- 512 MB RAM minimum (1 GB RAM recommended)
- 250 MB free disk space (English), 350 MB free disk space (International)
- CD-ROM drive or Internet connection to download the software
- Available USB port (required to use a MimioClassroom device)

## **Using this Guide**

---

This User Guide includes information for using the different MimioClassroom components. Depending on the types of MimioClassroom devices you have, some sections of this User Guide may not apply to you.

The following table provides a summary of the contents.

<b>User Guide Chapter</b>	<b>Description</b>
About MimioClassroom	This chapter gives an overview of the MimioClassroom products, including MimioStudio software, MimioTeach, MimioCapture, MimioVote, and MimioView.
MimioStudio	This chapter describes how to work with MimioStudio Notebook, Tools, and Gallery to create and deliver lessons and other presentations.
MimioTeach	This chapter describes how to set up and use MimioTeach with your whiteboard and a projector. This chapter also describes how to use MimioStudio in Interactive mode.
Mimio Interactive	This chapter describes how to set up and use Mimio Interactive with your whiteboard and a projector. This chapter also describes how to use MimioStudio in Interactive mode.
MimioCapture	This chapter describes how to set up and use MimioCapture. Included in this chapter are instructions for capturing notes and drawings from a MimioTeach-enabled whiteboard as digital ink using MimioCapture.
Mimio Capture Kit	This chapter describes how to set up and use Mimio Capture Kit. Included in this chapter are instructions for capturing notes and drawings from a Mimio Interactive-enabled whiteboard as digital ink using Mimio Capture Kit
MimioVote	This chapter describes how to set up and use MimioVote. Included in this chapter are instructions for creating and conducting MimioVote activities, as well as information about setting up and using MimioStudio Gradebook to save student grades and information.
MimioView	This chapter describes how to set up and use MimioView. Included in this chapter are instructions for displaying and annotating images in the MimioStudio View window.
Mimio Pad	This chapter describes how to set up and use Mimio Pad.
Using MimioStudio Recorder	This chapter describes how to use MimioStudio Recorder to create movies (with audio) of your presentations.
Sharing the Whiteboard Remotely	This chapter describes how to share your MimioTeach-enabled whiteboard using Microsoft NetMeeting.
Customizing MimioStudio	This chapter describes how to customize the features of the MimioStudio software and the MimioClassroom devices.
Getting Help	This chapter gives troubleshooting information for some common problems, describes how to check for and install MimioStudio software updates, and describes how to contact Technical Support.

<b>User Guide Chapter</b>	<b>Description</b>
Technical and Environmental Information	This chapter contains technical, certification, and safety information for the MimioClassroom products.

This page intentionally left blank for double-sided printing.



# MimioStudio

MimioStudio software includes all of the tools you need to make the most out of your MimioClassroom devices. You can also use the MimioStudio software without a MimioClassroom device to prepare presentations and manipulate previously created content.

## About MimioStudio

---

The following are the three main MimioStudio software applications that are used to create and present information.

- MimioStudio Notebook
- MimioStudio Tools
- MimioStudio Gallery

 For information about other MimioStudio applications, see the chapters of this User Guide that describe the MimioClassroom devices that you have.

MimioStudio Notebook provides a multi-page workspace for creating lessons and presentations. Using the MimioStudio Notebook is very similar to using other word processing or presentation software applications.

MimioStudio Notebook provides multiple authoring and editing tools for creating almost any type of content. You can use Notebook with MimioStudio Tools to create a variety of objects including text boxes, freehand writing and drawing, lines, arrows, and many basic shapes. Images can be imported into a Notebook, both as objects and as background images.

## About MimioStudio Notebook

You can create and present information with MimioStudio Notebook. Using Notebook is very similar to using other word processing or presentation software. Content created in Notebook can be saved as Mimio INK files or a variety of other file formats including HTML, JPEG, PNG, GIF, BMP, TIF, WMF, IWB, and PDF.

You can use Tab View to view a list of files that are attached to a Notebook or to view a thumbnail of each page in a Notebook.









## About MimioStudio Tools

MimioStudio Tools provides a comprehensive set of interactive tools and resources to create and present information. MimioStudio Tools is used to modify MimioStudio Notebook pages and to make screen annotations on the whiteboard.

The following table describes the major components of MimioStudio Tools.

	Selection tool		Zoom
	Pen		Brush
	Text		Highlighter
	Line		Arrow End
	Arrow Start		Arrow Both
	Rectangle		Ellipse
	Triangle		Right Triangle
	Five Pointed Star		Hexagon
	Pentagon		Shape Recognition
	Eraser		Insert file
	Screen clipping		Color picker
	More colors		Object Fill
	Outline and Fill color		Thickness slider
	Color palette		Solid Line
	Dash Line		Dotted Line
	Transparency		Gallery
	Applications (see below)		Right-click
	Interactive		Mouse
	Screen Annotation		

From the Applications tool, you can access the following:

- |  |  |  |
|--|--|--|
|  Reveal     |  Quick Vote |  Calculator  |
|  Spotlight  |  Recorder   |  Magnify     |
|  Text Tools |  View       |  Web Browser |

MimioStudio Tools has two views: a fully expanded view, for easy access to all features, and a compressed view, which takes up less space on the screen.

**To compress and expand MimioStudio Tools**

- ▶ Double-click  at the top of the MimioStudio Tools toolbar.

## About MimioStudio Gallery

MimioStudio Gallery contains elements that can be used to create your lessons and presentations, such as images, templates, movies, and previously created lessons. MimioStudio Gallery also contains Screen Annotation snapshots. You can customize the Gallery by adding your own elements.

MimioStudio Gallery consists of the following four main folders:

- **Screen Annotations** - contains all saved Screen Annotation snapshots.
- **Imported Content Packs** - contains any imported content that you have not yet added to the Gallery folder.
- **Questions and Results** - contains a variety of objects for use with MimioVote.
- **Gallery** - contains a number of different folders used to categorize items, such as Geography, Mathematics, and so on.

The Gallery folder and each of the Gallery subfolders can contain five different types of objects:

- **Images** - Images include pictures and graphics.
- **Templates** - Templates include backgrounds and predefined page layouts.
- **Multimedia** - Multimedia objects include movies, animation, and sound.
- **Questions and Results** - Questions and Results include objects for creating and displaying the results of MimioVote activities.
  -  This section of the Gallery does not appear until you move objects from the Questions and Results folder to the Gallery folder or a Gallery subfolder.
- **Lessons** - Lessons include lessons created using MimioStudio Notebook and imported documents. You can create your own lessons or import lessons created by someone else.

## Getting Started with MimioStudio



---

After installing MimioStudio, MimioStudio Notebook and MimioStudio Tools open on your desktop.

You can access many of the features in MimioStudio in several ways; from the menu bar, the MimioStudio Tools buttons, and the right-click menus. The available features change depending on what you are doing in the software. Be sure to explore the right-click menu options as you work with MimioStudio.









### Accessing MimioStudio Notebook

Several ways to access MimioStudio Notebook are shown in the following table.

To start from the	Do this
Desktop	Double-click  on the desktop.
Taskbar	Right-click  , and then choose  <b>Notebook</b> .
Start menu	Point to <b>Programs, MimioStudio</b> , and then choose <b>MimioStudio Notebook</b> .



## Accessing MimioStudio Tools

Several ways to access MimioStudio Tools are shown in the following table.

To start from the	Do this
Desktop	Double-click  on the desktop.
Taskbar	Right-click  , and then choose  <b>Tools</b> .
StartMenu	Point to <b>Programs, MimioStudio</b> , and then choose <b>MimioStudio Tools</b> .
MimioStudio Notebook	Do one of the following: <ul style="list-style-type: none"> <li>▪ Double-click  on the status bar.</li> <li>▪ Choose  <b>MimioStudio Tools</b> from the <b>Tools</b> menu.</li> </ul>
MimioTeach	Press the <b>Launch</b> button,  , on the MimioTeach bar, and then click  <b>Tools</b> in the Launch window.
Mimio Interactive	Press the <b>New page</b> button,  , on the Mimio Interactive bar.

## Accessing MimioStudio Gallery

Several ways to access MimioStudio Gallery are shown in the following table.

To start from	Do this
StartMenu	Point to <b>Programs, MimioStudio, Tools</b> , and then choose <b>MimioStudio Gallery</b> .
MimioStudio Tools	Click  on the MimioStudio Tools toolbar.
MimioStudio Notebook	Do one of the following: <ul style="list-style-type: none"> <li>▪ Double-click  on the status bar.</li> <li>▪ Choose  <b>Gallery</b> from the <b>Insert</b> menu.</li> </ul>

## Using MimioStudio Notebook

You can create and present information with MimioStudio Notebook. Using Notebook is very similar to using other word processing or presentation software. Content created in

Mimio INK files or a variety of other file formats including HTML, JPEG, PNG, GIF, BMP, TIF, WMF, IWB, and PDF.

You can use Tab View to view a list of files that are attached to a Notebook or to view a thumbnail of each page in a Notebook.

#### To open an existing Notebook

1. Start MimioStudio Notebook and click .
2. From the **Open** dialog box, navigate to and select the file to open and click **Open**.

#### To save a Notebook

1. Click the **Save** button, .
2. From the **Save As** dialog box, enter a name for your file in the **File name** box.
3. Choose the desired format from the **Save as type** list.
4. Click **Save**.

When saving in a format other than INK, the Select Pages dialog box appears.



5. From the Select Pages dialog box, do the following:
  - Select the pages to save under **Page Selection**.
  - Choose a size for the images from the **Size** list.
6. Click **OK**.

## Working with Pages

Each lesson or presentation created in MimioStudio Notebook consists of a series of pages. Pages can be viewed, presented, and edited in the main Notebook window or in Full Screen view. You can view a thumbnail of each page in a Notebook using the Thumbnails pane in the Tab View.

You can insert new pages, import pages from another Notebook, delete pages, and reorder pages. You can also change the size of a page, change the background of a page, and add transition effects between pages in your Notebook.



#### To insert a new page

- ▶ Do one of the following:
  - Click the **New Page** button, .
  - *(Capture mode only)* Press the **New Page** button, , on your MimioCapture tray.



#### To select a page

1. In the Tab View, click  to display the **Thumbnails** pane.
2. Do one of the following:
  - To select multiple pages, press **CTRL** and select each page.
  - To select multiple pages that are close to each other, drag a selection rectangle over the pages to select.
  - To select a range of pages, select the first page, and then press **SHIFT** and select the last page.
  - To select all pages, choose **Select All** from the **Edit** menu.





#### To insert a duplicate of an existing page

1. In the Tab View, click , and then select the page to duplicate.
2. Do one of the following:
  - Choose **Duplicate Page** from the **Insert** menu.
  - *(Capture mode only)* Press the **Copy Page** button, , on your MimioCapture tray.



#### To delete a page

1. In the Tab View, click , and then select the page to delete.
2. Click the **Delete** button, .

#### To import a page from another Notebook

1. In the Tab View of the source Notebook, click  and then select the page to import.
  2. Click the **Copy** button, .
  3. Select the location in the target Notebook to insert the page.
  4. Click the **Paste** button, .
-  You can also import pages by dragging the pages from the source Notebook to the target Notebook.

#### To insert the desktop as a new page

1. From MimioStudio Tools, click the **Screen Clipping** button, .  
The desktop is displayed with a transparent mask.
2. Click .  
The desktop is inserted as a new page in the Notebook.

#### To change the page size

1. Choose **Page Setup** from the **File** menu.  
The Page Setup dialog box appears.
2. Do one of the following:
  - From the **Page Size** list, choose any of the available display or device sizes.
  - From the **Page Size** list, choose **Custom**, and then enter the desired valued into the **Width** and **Height** boxes.
3. From the **Apply To** list, choose one of the following:
  - **Current Page** to apply the page size to the current page only.  
This option is not available if more than one page is selected in the Tab View.
  - **Selected Pages** to apply the page size to the selected pages.  
This option is only available if more than one page is selected in the Tab View.
  - **Whole Document** to apply the page size to all of the pages in the Notebook.
4. (Optional) Do one of the following:
  - To apply the page size to all new pages, select the **All new pages** check box.  
This option is only available if no MimioTeach device is connected.
  - To apply the page size to all new pages and the currently connected device, select the **The connected device** check box.  
This option is only available if a MimioTeach device is connected.
5. Click **OK** to apply your changes.

#### To change the background color of a page

1. Choose **Background** from the **Insert** menu.
2. From the **Background** dialog box, click **Color**.
3. From the **Color** dialog box, select a color, and then click **OK**.
4. From the **Apply To** list, select the pages to apply the background color to.
5. To apply the background color to all new pages, select the **All new pages** check box.
6. Click **OK** to apply your changes.

#### To change the background image of a page

1. Choose **Background** from the **Insert** menu.
2. From the **Background** dialog box, click **Image**.
3. From the **Open** dialog box, navigate to and select the image file that you want to use as your background.
4. Click **Open**.

The image is displayed in the **Preview** area.

 You can also import an image from another application or from the MimioStudio Gallery to use as a background. To do this, select the image and drag to the **Preview** area.

5. Select the display mode for the new background from the **Mode** list.

Mode	Result
Place	The image is placed in the top left corner of the page and is not resized.
Stretch	The image is resized to fill the entire page.
Tile	The image is tiled repeatedly to fill the entire page and is not resized.
Center	The image is placed in the center of the page and is not resized.

6. From the **Apply To** list, select the pages to apply the background to.
7. To apply the background to all new pages, select the **All new pages** check box.
8. Click **OK** to apply your changes.





#### To add a transition effect between pages

1. Choose **Page Transition** from the **Insert** menu.  
The Page Transition dialog box appears.
2. From the **Transitions** list, select the transition to apply.
3. From the **Apply To** list, select the pages to apply the transition to.
4. To apply the transition to all new pages, select the **All new pages** check box.
5. Click **OK**.

#### To sort pages

1. In the Tab View, click  to display the **Thumbnails** pane.
2. Select the pages to sort.
3. Drag the selected pages to the desired location.

#### To print a page

1. In the Tab View, click  to display the **Thumbnails** pane.
  2. Select the pages to print.
  3. Click the **Print** button, .  
The Print dialog box appears.
  4. Click **Print**.
-  To print the current page in Ink Capture mode, press the **Print Page** button, , on your MimioCapture tray.

## Creating an Activity

MimioStudio Notebook includes a wizard that you can use to quickly create and insert an activity into your Notebook.

The wizard guides you through the following steps to create and insert an activity:

- **Step 1: Define** - Define the subject, grade level, and template for the activity.
- **Step 2: Select** - Select the topic and categories for the activity, and when to show students the correct answers.
- **Step 3: Refine** - Refine the items available in the activity. You can also choose to display items as images or text.
- **Step 4: Review** - Review the activity and enter a student-focused objective.

### To start the wizard

1. Open a new or existing Notebook.
2. Choose **New Activity** from the **Insert** menu.  
The wizard starts.
3. Follow the instructions in the wizard.
4. When finished, click **Finish** to insert the activity as a new page in the MimioStudio Notebook.

### Creating an Activity - Step 1: Define

When you create an activity using the wizard, you define the subject, grade level, and template for the activity.

#### To define the activity

1. Under **Subject**, select a subject for the activity.
2. Under **Grade Level**, select the grade level of the students that will participate in the activity.
3. Under **Template**, select a template for the activity.
4. Click **Next**.

Next, you select the topic and categories for the activity.

### Creating an Activity - Step 2: Select

Once you have completed Step 1, you must select the topic and categories for the activity.

The topic and categories available depend on the subject and grade level you selected. The number of categories that you need to choose depends on the template you selected.

You also select when to reveal the correct answers to your students.



**To select the topic, categories, and when to show answers**

1. Select a topic for the activity from the topics list.
2. Select a category from each of the categories list.  
The categories available depend on the topic you selected.
3. Under **Reveal Answers**, select one of the following:
  - **Immediately following a student's response** to show if the student response is correct or incorrect immediately following each response.
    - 💡 Select this option when students are acquiring new skills. Providing feedback after each response allows you to explain to the students why a response is incorrect immediately after an error is made.
  - **When I choose the show answers button** to show the correct and incorrect answers only when you click the show answers button in the activity.
    - 💡 Select this option when students have already acquired skills. Providing feedback after all responses are given allows you to test the students to see if they can complete the entire activity on their own.
4. Do one of the following:
  - Click **Next** to go to the next page of the wizard.
  - Click **Review** to skip step 3, Refine, and continue to step 4, Review.

**Creating an Activity - Step 3: Refine**



Once you have completed Step 1 and Step 2, the wizard automatically generates the choice pool for the activity. The choice pool contains the set of available items students will use to complete the activity.

Optionally, you can further refine your activity in the following ways:

- Change the state of items in the library to always include or exclude from the choice pool.
  - Display items as images or text. (Not available for all items.)
  - Increase or decrease the number of items available in the choice pool.
  - Change the number of items belonging to each category in the choice pool.
  - Refresh the choice pool with new items from the library.
- 💡 Refining the activity is optional. To skip this page of the wizard and move on to the next page, click **Next**.

**Selecting Items to Include or Exclude**

You can choose to always include or always exclude items from the activity. The following table describes the available states for each item.

	Always include item in choice pool.
	Never include item in choice pool.
No mark	Randomly include item in choice pool.

**To select items to always include or exclude from the activity**

1. Under **Library**, select the item that you want to always include or exclude.
2. Click one of the following:
  - **Include** to always include the item in the choice pool.
  - **Exclude** to never include the item in the choice pool.

The state of the item is updated in the library.

#### **To clear the include or exclude state for an item**

1. Select the included or excluded item.
2. Click **Clear**.

The state of the item is updated in the library.

#### **Displaying Items as Images or Text**

You can choose to display the items in the activity as images or as text.

#### **To display items as images or text**

- ▶ Select one of the following from the **Display Type** list:
  - **Text** to display all items in the library and the choice pool as text.
  - **Image** to display all items in the library and the choice pool as images. (Not available for all items.)

#### **Changing Choice Categories**

The number of items in the choice pool that belong to each category is determined automatically. You can replace some of the items in the choice pool with items from a different category so that the choice pool contains more choices from one category and fewer from another.

The maximum number of items available in the choice pool is 20. You can increase or decrease the number of items in the choice pool by adding or removing items.

#### **To change an item in the choice pool**

1. Under **Choice Pool**, select the item or empty position to change.
2. Do one of the following:
  - To replace or add an item, click the desired category for the new item.
  - To remove the item and leave the position empty, click **Empty**.

#### **Refreshing the Choice Pool**

You can refresh the choice pool at any time. You should refresh the choice pool after making any changes to the items in the library.

#### **To refresh the choice pool**

- ▶ Click .

### **Creating an Activity - Step 4: Review**

You can review the activity before inserting the activity into your Notebook. You can also enter a student-focused objective for your activity.

#### **To review the activity and enter an objective**

1. Review the activity.
  - 💡 If necessary, click **Back** to return to the previous pages of the wizard and make any desired changes.
2. Enter an objective in the **Objective** box.
  - 💡 For information about writing a student-focused objective, see Writing an Objective.
3. Click **Finish**.
 

The activity is inserted as a new page in the MimioStudio Notebook.

### Writing an Objective

The purpose of the objective is to communicate expectations clearly so that the teacher and the students have a shared understanding of the performance standards by which the student will be evaluated. Remember that a good student-focused objective includes the following four parts:

- **Actor** - The person who will complete the task (for example, *the student*)
- **Intent** - The targeted category of performance (for example, *identify birds and reptiles*)
- **Indicator** - The observable and measurable behavior that reflects the intent (for example, *dragging and dropping*)
- **Outcome** - The product that is to be evaluated (for example, *images sorted into columns*)

**Example:** *The student will identify birds and reptiles by dragging the images from the choice pool into the corresponding columns.*

Optionally, you can include the following fifth part in an objective:

- **Criterion** - The level of performance that is targeted for mastery. This may be stated as accuracy and/or rate.

#### Examples:

- *The student will identify birds and reptiles by dragging the images from the choice pool into the corresponding columns with 90% accuracy.*
- *The student will identify birds and reptiles by dragging the images from the choice pool into the corresponding columns, with at least 9 out of 10 correct in less than one minute.*

### Attaching Files

You can attach any type of file to a MimioStudio Notebook. Once a file is attached to the Notebook, you can quickly open the file directly from within MimioStudio Notebook.

#### To attach a file to a Notebook

1. In the Tab View, click  to display the **File Attachment** pane.
2. On your computer, navigate to and select the file to attach to the Notebook.
3. Drag the file to the **File Attachment** pane.

The file is attached to the Notebook.

#### To open an attached file

1. In the Tab View, click  to display the **File Attachment** pane.
2. Double-click the file to open.

## Using MimioStudio Tools

---

Using MimioStudio Tools, you can create a wide variety of objects on any MimioStudio Notebook page, including lines, shapes, and freehand drawing and writing.





See [Accessing MimioStudio Tools](#) for information on accessing MimioStudio Tools.

### Creating Objects





MimioStudio Tools provides tools for inserting freehand writing or drawing into your MimioStudio Notebook, as well as lines, arrows, basic shapes, and formatted text. You can also import images and multimedia objects, or insert a clipping of your screen into your Notebook using Tools.

Once you select a drawing tool, that tool remains selected until you select a different drawing tool or the selection tool.

#### To use the freehand pen



1. Click the **Pen** button, .
2. (Optional) To adjust the line width, drag the Thickness slider.
3. (Optional) To adjust the line color, do one of the following:
  - Select a color from the Color Palette.
  - Click , and then select a color from the **Color** dialog box.
  - Click , and then select a color from the desktop.
4. (Optional) To adjust the transparency of the line, click the **Transparency** button, , and then choose a transparency percentage.
5. Place the cursor where you want the ink stroke to start on the page.
6. Drag the cursor to draw ink strokes.

#### To use the freehand brush

1. Click the **Brush** button, .
2. (Optional) To adjust the line width, drag the Thickness slider.
3. (Optional) To adjust the line color, do one of the following:
  - Select a color from the Color Palette.
  - Click , and then select a color from the **Color** dialog box.
  - Click , and then select a color from the desktop.
4. (Optional) To adjust the transparency of the line, click the **Transparency** button, , and then choose a transparency percentage.
5. Place the cursor where you want the brush stroke to start on the page.
6. Drag the cursor to draw brush strokes.

#### To highlight a portion of the display









1. Click the **Highlighter** button, .
2. (Optional) To adjust the highlighter width, drag the Thickness slider.

3. (Optional) To change the color, do one of the following:
  - Select a color from the Color Palette.
  - Click , and then select a color from the **Color** dialog box.
  - Click , and then select a color from the desktop.
4. Place the cursor where you want the highlight stroke to start on the page.
5. Drag the cursor over the area you want to highlight.

#### To erase ink and highlighting

1. Click the **Eraser** button, .
2. (Optional) To adjust the eraser width, drag the Thickness slider.
3. Drag the cursor over the ink or highlighter strokes you want to erase.

#### To add a line or shape











1. Click the line type or shape you want to add.
2. (Optional) To adjust the line or outline width, drag the Thickness slider.
3. (Optional) To change the line or outline color, select the Outline Color box, and then do one of the following:
  - Select a color from the Color Palette.
  - Click , and then select a color from the **Color** dialog box.
  - Click , and then select a color from the desktop.
4. (Optional) To adjust the fill color, select the Fill Color box, and then do one of the following:
  - Select a color from the Color Palette.
  - Click , and then select a color from the **Color** dialog box.
  - Click , and then select a color from the desktop.
5. To change the line or outline style, click  and choose one of the following:
  -  **Solid Line**
  -  **Dash Line**
  -  **Dotted Line**
6. (Optional) To adjust the transparency of the line or shape, click the **Transparency** button, , and then choose a transparency percentage.
7. Place the cursor where you want the line or shape to start on the page.
8. Drag the cursor to draw the line or shape.

#### To add formatted text



1. Click the **Text** button, .
2. Place the cursor where you want the text to start on the page.
 

For a fixed width text box, place the cursor where you want the text box to start on the page and then drag to the desired width.
3. Select a font style, size, color, and an alignment option for the text.
4. Enter text in the text box.

#### To draw a shape





1. Click the **Shape Recognition** button, .
  2. (Optional) To adjust the outline width, drag the Thickness slider.
  3. (Optional) To change the outline color, select the Outline Color box, and then do one of the following:
    - Select a color from the Color Palette.
    - Click , and then select a color from the **Color** dialog box.
    - Click , and then select a color from the desktop.
  4. (Optional) To adjust the fill color, select the Fill Color box, and then do one of the following:
    - Select a color from the Color Palette.
    - Click , and then select a color from the **Color** dialog box.
    - Click , and then select a color from the desktop.
  5. To change the line or outline style, click  and choose one of the following:
    -  **Solid Line**
    -  **Dash Line**
    -  **Dotted Line**
  6. (Optional) To adjust the transparency of the shape, click the **Transparency** button, , and then choose a transparency percentage.
  7. Place the cursor where you want the shape to start on the page.
  8. Drag the cursor to draw the shape.
-  The Shape Recognition tool can be used to draw circles, ellipses, triangles, rectangles, squares, and lines.

#### To import a picture, multimedia object, or document

1. From MimioStudio Tools, click the **Insert File** button, .
  2. From the **Open** dialog box, select the file to import.
  3. Click **Open**.
- The image or object is displayed on the Notebook page.
-  You can also copy and paste images from another application, or drag images from another application into Notebook.

#### To insert a screen clipping

1. From MimioStudio Tools, click the **Screen Clipping** button, .
 

The desktop is displayed with a transparent mask.
2. Do one of the following:
  - Click  to insert a rectangular screen clipping.
  - Click  to insert an elliptical screen clipping.
  - Click  to insert a free-form screen clipping.
3.  To insert the entire desktop as a new page in the Notebook, click .
  3. Drag the cursor to select the area to capture.

The selected area is inserted in the Notebook page.

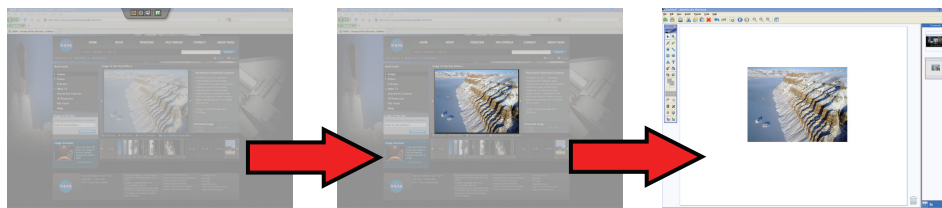

## Manipulating Objects

Objects on a page can be moved, rotated, copied, deleted, locked, and have their properties adjusted.

### To select an object

1. From MimioStudio Tools, click the **Selection** button, .
2. Do one of the following:
  - Click the object to select.
  - To select multiple objects, press **CTRL** and select each object.
  - To select multiple objects that are close to each other, drag a selection rectangle over the objects to select.
  - To select all objects on a page, choose **Select All** from the **Edit** menu.

### To move an object

1. Select the object to move.
2. Position the cursor over the object.  
The cursor changes to the move cursor, .
3. Drag the object to the desired location.

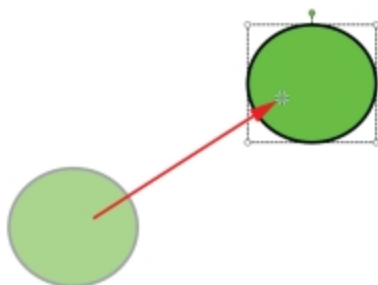

### To resize an object

1. Select the object to resize.  
A frame is displayed around the object.
2. Position the cursor over one of the white sizing handles.  
The cursor changes to the resize cursor, .

3. Drag the cursor to resize the object.

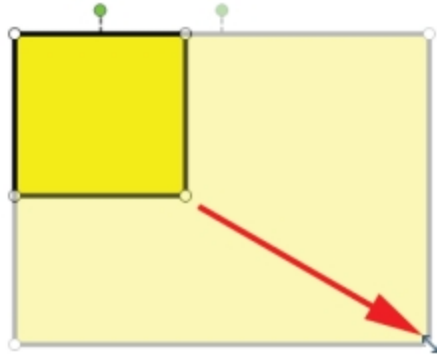

- ▢ To constrain object proportions during resizing, right-click the object and choose **Fixed Aspect Ratio**.

#### To rotate an object

1. Select the object to rotate.  
A frame is displayed around the object.
2. Position the cursor over the green rotation handle.  
The cursor changes to the rotation cursor, .
3. Drag the cursor to rotate the object.  
To snap to one of the predefined 45° increments, move the rotate cursor and release over the predefined rotation anchor point.



#### To lock the position and properties of an object

1. Select the object to lock.
  2. From the **Format** menu, point to **Locking**, and then choose **Lock**.
- ▢ A locked object cannot be selected.

#### To unlock an object

- ▶ From the **Format** menu, point to **Locking**, and then choose **Unlock All**.  
Objects can only be unlocked collectively; you cannot unlock individual objects.





#### To delete an object

1. Select the object to delete.
2. Drag the object to the trash can, .



**To reorder objects**

1. Select the object to reorder.
2. Choose **Order** from the **Format** menu.
3. Choose how to order the object.

Option	Action
 <b>Front</b>	Brings the selected object to the front of the order.
 <b>Back</b>	Sends the selected object to the back of the order.
 <b>Forward</b>	Steps the object forward in the order, by one.
 <b>Backward</b>	Steps the object backward in the order, by one.







**To group objects**

1. Select the objects to group.
2. From the **Format** menu, point to **Grouping**, and then choose  **Group**.



**To ungroup objects**

1. Select the objects to ungroup.
2. From the **Format** menu, point to **Grouping**, and then choose  **Ungroup**.

**To edit object properties**

1. Select the object to edit.
2. To adjust the line or outline width, drag the Thickness slider.
3. To adjust the color, select the Outline Color box or the Fill Color box, and then do one of the following:
  - Select a color from the Color Palette.
  - Click , and then select a color from the **Color** dialog box.
  - Click , and then select a color from the desktop.
4. To change the line or outline style, click  and choose one of the following:
  -  **Solid Line**
  -  **Dash Line**
  -  **Dotted Line**
5. To adjust the transparency, click the **Transparency** button, , and then choose a transparency percentage.

**To change the fill color of an object**

1. From MimioStudio Tools, click the **Object Fill** button, .
2. Do one of the following:
  - Select a color from the Color Palette.
  - Click , and then select a color from the **Color** dialog box.
  - Click , and then select a color from the desktop.



3. Click the object to change the fill color for.

 To change the fill color for an object that currently has no fill color, click the object border.

#### **To edit text**



1. Double-click the text box.
2. Select the text to adjust, or enter new text.
3. Adjust the font style, size, color, or alignment.

#### **To import an object from another Notebook page**



1. Select the object to import from the source Notebook page.
2. Click the **Copy** button, .
3. Navigate to the target Notebook page.
4. Click the **Paste** button, .

 You can also import an object by dragging the object from the source page to the target page.

#### **To convert ink to text**

1. Select the objects to convert.  
All selected objects are combined into one text object.
2. Do one of the following:
  - Right-click, and then choose  **Recognize Text**.
  - Choose  **Recognize Text** from the **Tools** menu.

#### **To convert ink to shapes**

1. Select the objects to convert.
2. Do one of the following:
  - Right-click, and then choose  **Recognize Shapes**.
  - Choose  **Recognize Shapes** from the **Tools** menu.

#### **To snap objects to grid**

1. Choose  **Grid** from the **View** menu.  
The Grid dialog box appears.
2. To force objects to snap to grid, select the **Snap objects to grid** check box.
3. To allow objects to snap to angles, select the **Snap objects to angles** check box.
4. To adjust the spacing between grid snap locations, enter the desired value into the **Spacing** box.
5. To display a grid on the screen, select the **Display grid on screen** check box.
6. To make the grid settings permanent for each new MimioStudio Notebook, select the **Set as default for all new documents** check box.
7. Click **OK**.

## **Adding Actions to Objects**

Objects can have actions associated with them. You can associate an action with any object that you create or import into a MimioStudio Notebook; you cannot add an action to a template or background.

You can choose to perform the associated action each time you click the object or each time you drag the object.

 You can associate two different actions with a single object. For example, you can choose to launch a hyperlink when you click an object and clone the object when you drag the object. However, you cannot associate two different hyperlinks or two different sounds with the same object.

There are three types of actions that you can associate with objects:

- **Launch Hyperlink** - opens a file, a web page, or a different page within a Notebook.
- **Clone** - creates a copy of the object on the Notebook page.
- **Play Sound** - plays a sound file.

#### **To add a hyperlink to an object**

1. Select the object to add the hyperlink to.
2. Choose **Hyperlink** from the **Insert** menu.  
The Action Settings dialog box appears.
3. Select one of the following from the **Action** list:
  - **On Click** - to launch the hyperlink each time the object is clicked.
  - **On Drag** - to launch the hyperlink each time the object is dragged.
4. Select **Launch Hyperlink** from the **Feature** list.
5. Select **Existing file or Web Page** from the **Link To** list.  
Alternately, select a page from within the current Notebook from the **Link To** list.
6. Enter a file name or web address to link to in the **Address** box.  
Alternately, click **Browse** to search for a file to link to.
7. Click **OK** to add the hyperlink to the object.

#### **To add cloning to an object**

1. Select the object to add the clone action to.
2. Choose **Action Settings** from the **Insert** menu.  
The Action Settings dialog box appears.
3. Select one of the following from the **Action** list:
  - **On Click** - to create a copy of the object each time the object is clicked
  - **On Drag** - to create a copy of the object each time the object is dragged
4. Select **Clone** from the **Feature** list, and then click **OK**.

 You can also add the clone action to an object by choosing Clone from the Insert menu. By default, a copy of the object is created whenever you drag the object.

#### **To add a sound to an object**

1. Select the object to link the sound file to.
2. Choose **Action Settings** from the **Insert** menu.  
The Action Settings dialog box appears.
3. Select one of the following from the **Action** list:
  - **On Click** - to play the sound file each time the object is clicked
  - **On Drag** - to play the sound file each time the object is dragged
4. Select **Play Sound** from the **Feature** list.

5. Click **Load**.  
The Open dialog box appears.
6. Navigate to and select the sound file to link to the object, and then click **Open**.
7. Click **OK** in the **Action Settings** dialog box.

**To remove an action from an object**

1. Select the object with the action to remove.
2. Choose **Action Settings** from the **Insert** menu.  
The Action Settings dialog box appears.
3. Choose **None** from the **Feature** list, and then click **OK**.

## Using MimioStudio Gallery

---

MimioStudio Gallery consists of the following four main folders:

- **Screen Annotations** - contains all saved Screen Annotation snapshots.
- **Imported Content Packs** - contains any imported content that you have not yet added to the Gallery folder.
- **Questions and Results** - contains a variety of objects for use with MimioVote.
- **Gallery** - contains a number of different folders used to categorize items, such as Geography, Mathematics, and so on.

The Gallery folder and each of the Gallery subfolders can contain five different types of objects:

- **Images** - Images include pictures and graphics.
- **Templates** - Templates include backgrounds and predefined page layouts.
- **Multimedia** - Multimedia objects include movies, animation, and sound.
- **Questions and Results** - Questions and Results include objects for creating and displaying the results of MimioVote activities.  
 This section of the Gallery does not appear until you move objects from the Questions and Results folder to the Gallery folder or a Gallery subfolder.
- **Lessons** - Lessons include lessons created using MimioStudio Notebook and imported documents. You can create your own lessons or import lessons created by someone else.

See [Accessing MimioStudio Gallery](#) for information on accessing MimioStudio Gallery.

**To navigate MimioStudio Gallery**

- ▶ Click any folder to view the available items in that folder.
- ▶ Click the plus sign next to a Gallery folder to see any subfolders that are contained in that Gallery folder.

**To select a Gallery item**

1. Navigate to the Gallery folder that contains the item you want to select.
2. Do one of the following:
  - Click the Gallery item to select.
  - To select multiple items, press **CTRL** and select each item.

- To select multiple items that are close to each other, drag a selection rectangle over the items to select.
- To select a range of items, select the first item, and then press **SHIFT** and select the last item.
- To select all items, right-click, and then choose **Select All**.

## Importing Gallery Items into a Notebook

You can import any Gallery item into a MimioStudio Notebook to add to your presentation.

### To import a Gallery item into a Notebook

1. Select the image, template, multimedia item, questions and results object, or lesson to import.
2. Drag the item into the Notebook.

 You can also import items by double-clicking or by copying and pasting the items into a Notebook.

## Customizing the Content of the Gallery

The MimioStudio Gallery is fully expandable and modifiable, so you can add your own folders, pictures, templates, multimedia items, and lessons.

You can also add Microsoft Word, Excel, PowerPoint, and PDF documents to the Gallery. All imported documents are placed in the Lessons section of the MimioStudio Gallery

 MimioStudio does not support network or shared galleries.

### To import a Gallery folder from a Gallery file

1. Click the **Import Content Pack** button, .
2. From the **Open** dialog box, navigate to and select the Gallery file to import.
3. Click **Open**.

The contents of the Gallery file are added to the Imported Content Packs folder in MimioStudio Gallery.

4. Review the imported content and make any desired changes.
5. To move the content to the Gallery folder, right-click the folder to move and then choose **Install**.

The content is moved to the Gallery folder.

### To add a new Gallery folder

1. Select the main Gallery folder or a Gallery subfolder to add the new folder to.
2. Click the **New Folder** button, .

The Gallery Item Properties dialog box appears.

3. Enter a name for the new folder in the **Name** box.
4. (Optional) Enter a keyword in the **Keywords** box to make the new folder searchable from the Gallery search bar.
5. Click **OK**.

### To add a new item to a folder

1. Select the folder to add the item to.
2. Click the **Insert File** button, .

3. From the **Open** dialog box, navigate to and select the file to import.
4. Click **Open**.



The item is inserted in the appropriate area of the Gallery folder.

-  You can also add new items by selecting one or more items, and then dragging and dropping or copying and pasting them into a Gallery folder.

#### **To create a template from a Notebook image**

1. Right-click and drag the image into the Gallery.  
The right-click menu appears.
2. Choose **Insert as template**.

#### **To copy an existing Gallery item**

1. Select the Gallery item to copy.
  2. Click the **Copy** button, .
  3. Select a Gallery folder to insert the new item into.
  4. Click the **Paste** button, .
- The item is inserted in the appropriate area of the Gallery folder.

#### **To delete a Gallery item**

1. Select the Gallery item to delete.
  2. Click the **Delete** button, .
  3. Click **Yes**.
- A delete confirmation dialog box appears.

#### **To find similar Gallery items**

1. Right-click the Gallery item, and then choose **Open Folder**.
2. If the item is contained in more than one folder, choose the folder to open.  
The folder containing the selected item opens in MimioStudio Gallery.

## **Exporting a Gallery Folder to a Gallery File**

Entire Gallery folders can be exported and imported into the MimioStudio Gallery as Gallery (MCF) files. You can then share Galleries that you have created with other MimioStudio users.

-  MimioStudio does not support network or shared galleries.

#### **To export a Gallery folder to a Gallery file**

1. Select the Gallery folder to export.
2. Click the **Export Content Pack** button, .
3. From the **Save As** dialog box, enter a name for the file in the **File Name** box.
4. Select a location to save the file to.
5. Click **Save**.

## **Working with Saved Annotation Snapshots**

---

MimioStudio automatically saves a snapshot of the annotated screen each time you exit Screen Annotation mode. These snapshots are saved in the Screen Annotations folder in MimioStudio Gallery.

For information about creating Screen Annotation snapshots, see [Marking Up the Display Using Screen Annotations](#).

## Viewing Screen Annotation Snapshots

You can view your saved screen annotations from the Screen Annotations folder in MimioStudio Gallery.

### To view Screen Annotation snapshots

1. Start MimioStudio Gallery.
2. Select the **Screen Annotations** folder.

### To select a snapshot

- ▶ Do one of the following:
  - Click on the snapshot to select.
  - To select multiple snapshots, press **CTRL** and select each snapshot.
  - To select multiple snapshots that are close to each other, drag a selection rectangle over the snapshots.
  - To select a range of snapshots, select the first snapshot and then press **SHIFT** and select the last snapshot.
  - To select all snapshots, right-click, and then choose **Select All**.

## Renaming an Annotation Snapshot

Screen Annotation snapshots are saved in chronological order, using the date and time that the snapshot was created as the name of the snapshot. You can rename a snapshot any time after it has been saved.

### To rename a snapshot

1. Select the snapshot to rename.
2. Right-click and choose **Properties**.
3. Enter a name for the snapshot in the **Name** box and click **OK**.

## Adding Keywords to an Annotation Snapshot

You can add keywords to any snapshot so that you can use the search bar in MimioStudio Gallery to find that snapshot later.

### To add keywords to a snapshot

1. Select the snapshot to add keywords to.
2. Right-click and choose **Properties**.
3. Enter each keyword on a separate line in the **Keywords** box and click **OK**.

## Searching for an Annotation Snapshot

You can search for a specific snapshot using the search bar in MimioStudio Gallery. You can search for a snapshot using a keyword or part of the snapshot name.

### To search for a specific snapshot

1. Select the **Screen Annotations** folder in the Gallery.
2. Enter text to search for in the **Search** box.

All snapshots associated with the text appear in the preview area of the Gallery.

### **Importing an Annotation Snapshot**

You can import a snapshot into an open Notebook.

#### **To import a snapshot**

1. Open a MimioStudio Notebook.
2. Select the snapshot to import.
3. Drag the selected snapshot into the target Notebook.

### **Pasting an Annotation Snapshot Into Another Application**

Annotation snapshots can be used in other applications such as Microsoft Word or PowerPoint.

#### **To paste a snapshot into another application**

1. Select the snapshot to copy.
2. Click the **Copy** button, .
3. Navigate to the target application.
4. Right-click, and then choose **Paste**.

Alternatively, you can drag the selected snapshot into the target application.

### **Printing Annotation Snapshots**

You can print a snapshot directly from the Screen Annotations folder in MimioStudio Gallery.

#### **To print a snapshot**

1. Select the snapshot to print.
2. Right-click and choose **Print**.

### **Deleting Annotation Snapshots**

You can delete snapshots from the Screen Annotations folder.

#### **To delete a snapshot**

1. Select the snapshot to delete.
2. Click the **Delete** button, .
- A delete confirmation dialog box appears.
3. Click **Yes**.

## **Delivering Interactive Notebook Lessons and Presentations**

---

MimioStudio Notebook can be used to deliver lessons and presentations that were created in or imported into a MimioStudio Notebook.



## Using Fullscreen View

For presenting information, the Fullscreen view can be used to fill the entire screen with the current page.

The MimioStudio Notebook standard toolbar and all MimioStudio Tools are available in Fullscreen view.

### To access the Fullscreen view





- ▶ Click the **Fullscreen** button, .

The current page fills the entire screen and the MimioStudio Notebook standard toolbar remains visible.

## Navigating Through a Presentation

### To navigate through a Notebook presentation

- ▶ Use the MimioStudio Notebook standard toolbar to navigate through the Notebook presentation.

Button	Action
	Use this button to enter or exit the Fullscreen view.
	Use this button to insert a new page
	Use this button to return to the previous page in the Notebook.
	Use this button to advance to the next page in the Notebook.

## Working with Multimedia Objects

You can play, pause, fast forward, and rewind movie, animation, and sound objects you added to your presentation.

### To play video or audio

- ▶ Click anywhere on the movie, animation, or sound object to play.

### To show and hide the video and audio controls

1. While the video or audio is playing, click once anywhere on the object to view the object controls.



2. Click the object again to hide the controls.

### To pause, fast forward, or rewind video or audio

- ▶ Do one of the following:
  - To pause the video or audio, click .
  - To fast forward the video or audio, drag the slider to the right.
  - To rewind the video or audio, drag the slider to the left.

This page intentionally left blank for double-sided printing.

## Chapter 3

# MimioTeach

Using MimioTeach with a projector, you can deliver lessons and presentations directly from your whiteboard. Using MimioStudio Interactive mode, you control the movement of the cursor on your screen with the MimioTeach stylus, much like you would with a mouse at your computer.

### What's Included

The MimioTeach package contains the following items:

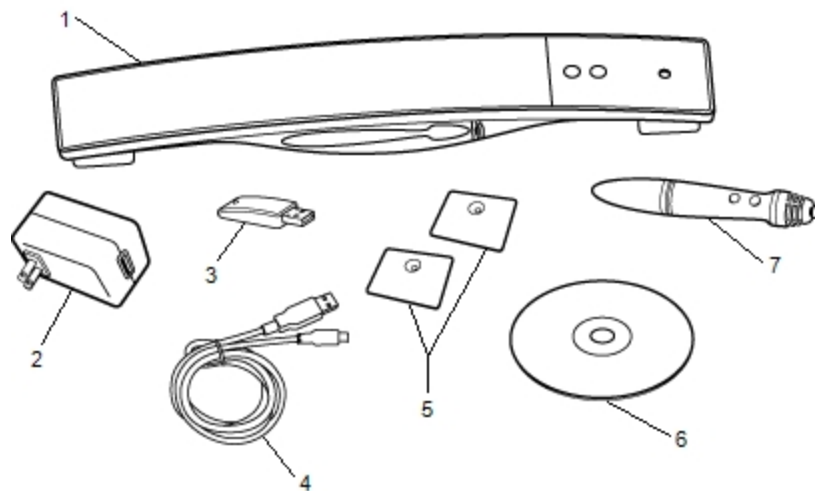

1	MimioTeach bar	5	Mounting plates
2	USB power adapter	6	MimioStudio DVD
3	MimioHub	7	MimioTeach stylus
4	USB cable		

If you are missing any of the items above, contact Customer Support.

### About MimioTeach

You can use the MimioTeach bar and stylus in MimioStudio Interactive mode to deliver lessons and presentations.

You can also use the MimioTeach bar with MimioCapture to capture notes from your whiteboard into MimioStudio Notebook. For more information about using MimioTeach with MimioCapture, see MimioCapture.

The following figure shows the major components of the MimioTeach.

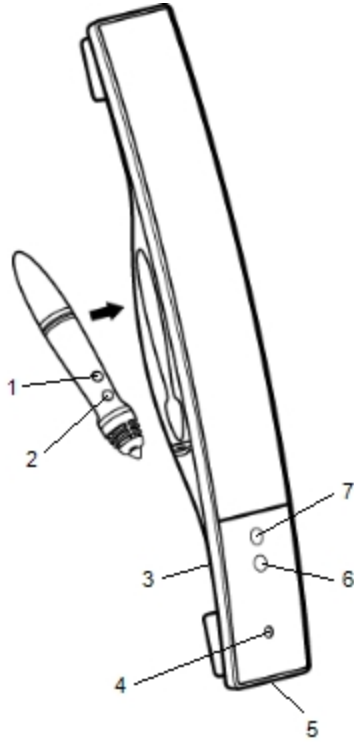

1	Start Tools (button A)	5	USB/Power connector
2	Hover/Right-click (button B)	6	Launch
3	MimioHub dock	7	Calibrate
4	Power/Status light		

### Status Lights

The status light visually shows the status of the MimioTeach bar.

---

Off	Not receiving power; USB/power cable is not connected or MimioTeach is turned off.
Solid Green	MimioTeach is connected and receiving power; MimioStudio software is running.
Flashing Green	MimioTeach is connected or connecting, and receiving power; MimioStudio software is not running.
Solid Amber	MimioTeach cannot find an available MimioHub.
Flashing Amber	MimioTeach is searching for an available MimioHub.

### **About MimioStudio Tools**









With the various presentation tools found in MimioStudio Tools you can focus your audience on a specific area of the screen by displaying only certain parts of the screen. You can also annotate the screen with the drawing tools available in MimioStudio Tools using the Screen Annotation feature.

For more information about MimioStudio Tools, see [Marking Up the Display Using Screen Annotations](#).

The following table describes the major components of MimioStudio Tools.

	Selection tool		Zoom
	Pen		Brush
	Text		Highlighter
	Line		Arrow End
	Arrow Start		Arrow Both
	Rectangle		Ellipse
	Triangle		Right Triangle
	Five Pointed Star		Hexagon
	Pentagon		Shape Recognition
	Eraser		Insert file
	Screen clipping		Color picker
	More colors		Object Fill
	Outline and Fill color		Thickness slider
	Color palette		Solid Line
	Dash Line		Dotted Line
	Transparency		Gallery
	Applications (see below)		Right-click
	Interactive		Mouse
	Screen Annotation		

From the Applications tool, you can access the following:

- |  |  |  |
|--|--|--|
|  Reveal     |  Quick Vote |  Calculator  |
|  Spotlight  |  Recorder   |  Magnify     |
|  Text Tools |  View       |  Web Browser |

---

## Getting Started

---

Review the following topics to install and start using your MimioTeach.

- Setting Up the MimioTeach Stylus
- Setting Up the MimioTeach Bar
- Setting Up Interactive Mode

### Setting Up the MimioTeach Stylus

The MimioTeach stylus is powered by a rechargeable lithium-ion battery. The battery recharges whenever the stylus is docked on the MimioTeach bar.

#### To set up the MimioTeach stylus

1. Turn the top of the stylus counter-clockwise to separate the top from the body of the stylus.

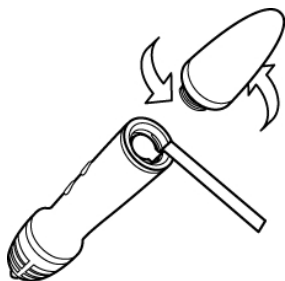

2. Remove the plastic strip from the stylus.

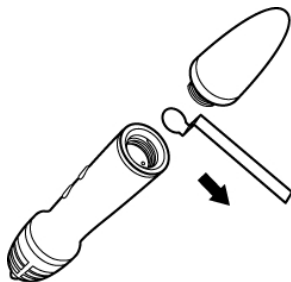

3. Replace the top onto the body of the stylus and turn clockwise to attach.

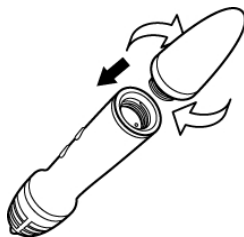

### Setting Up the MimioTeach Bar

The MimioTeach bar comes pre-linked to the included MimioHub. You can also use this MimioHub to connect other MimioClassroom devices to your computer, such as MimioVote.

- 💡 When not in use, the MimioHub can be stored in the MimioHub dock on the back of the MimioTeach bar.

MimioTeach is powered using the included USB cable and power adapter.

- 📄 Optionally, MimioTeach can be powered using three AAA batteries. For information about using batteries to power the MimioTeach bar, see [Inserting the Batteries](#).

**To set up the MimioTeach bar**

1. Plug the USB cable into the USB port on the power adapter.

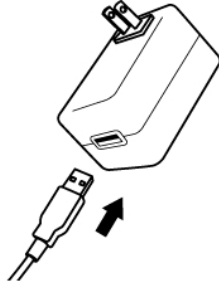

2. Plug the other end of the USB cable into the USB port on the MimioTeach bar.

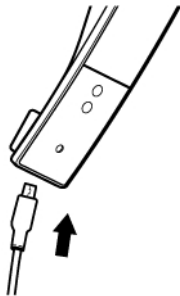

3. Plug the power adapter into a power outlet.

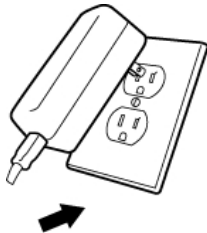

4. Place the MimioTeach bar along the left edge of the whiteboard as shown.



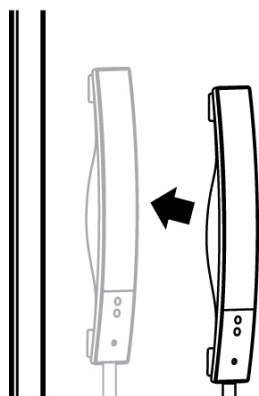

The MimioTeach bar attaches securely to any magnetic whiteboard. See [Mounting MimioTeach to a Non-Magnetic Whiteboard](#) for information about mounting the bar to a non-magnetic whiteboard.

5. Plug the MimioHub into an available USB port on your computer.

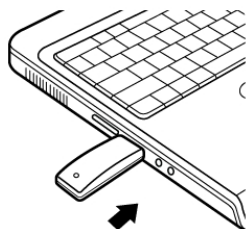

- If you do not want to connect the MimioTeach bar to your computer wirelessly, you can link the bar to your computer using the included USB cable without the power adapter. The bar will be powered by USB through your computer.

## Setting Up Interactive Mode

Using MimioStudio Interactive mode, you can deliver lessons and presentations directly from your whiteboard.

To use Interactive mode you need a projector, a MimioTeach-enabled whiteboard, and a MimioTeach stylus. Combined, these devices make for a powerful tool for delivering lessons and presentations.

## Projecting Your Desktop

If you are presenting from a MimioStudio Notebook or another application, such as a PowerPoint presentation, you can open the application before or after Interactive mode is enabled and calibrated.

### To start Interactive mode

1. Project your desktop image onto your whiteboard.  
Refer to your projector's documentation for instructions on how to project your desktop image.
2. Adjust the projected image to have a 2-inch to 3-inch buffer between the edge of your projection and your MimioTeach.

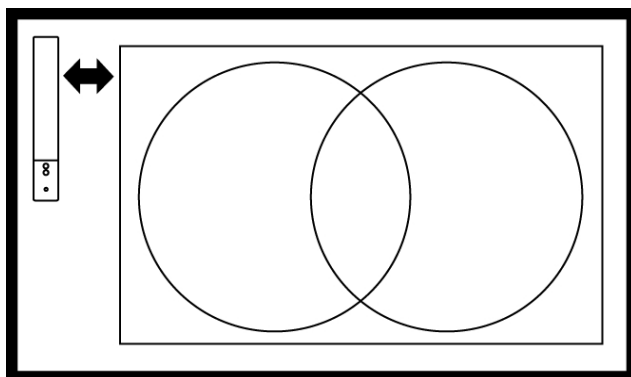

3. Click the MimioTeach stylus anywhere on the whiteboard. Interactive mode starts and the calibration screen appears.

#### To exit Interactive mode

- ▶ Do one of the following:
  - Press the **Interactive** button, ⊕, twice on the MimioTeach bar.
  - Start MimioStudio Tools, click **Interactive** , and then click **Exit**.
  - Start MimioStudio Settings, select **Interactive**, and then click **Disable**.  
See Customizing MimioStudio for information on how to access MimioStudio Settings.

### Calibrating Interactive Mode

Each time Interactive mode is enabled, you are prompted to calibrate using the MimioTeach stylus.

When using a permanently installed whiteboard and projector, you do not need to recalibrate Interactive mode after the first session. See Adjusting the Interactive Settings.

#### To calibrate Interactive mode

1. If the calibration screen does not appear when you start Interactive mode, do one of the following:
  - Press the **Interactive** button, ⊕, on your MimioTeach bar.
  - Start MimioStudio Tools, click the **Interactive** button, , and then click **Recalibrate**.
  - Start MimioStudio Settings, select **Interactive**, and then click **Calibrate**.
2. Press the MimioTeach stylus down on the whiteboard at the center of each of the nine calibration targets.

Make sure to hold the stylus perpendicular to the writing surface as you click.

The calibration target disappears and the next calibration target appears.

When the calibration screen disappears, Interactive mode is enabled.

## Using MimioTeach

You can use the MimioTeach bar and stylus in MimioStudio Interactive mode to deliver lessons and presentations. In MimioStudio Interactive mode, you control the movement of

the cursor on your screen with the MimioTeach stylus, much like you would with a mouse at your computer.

You can also use the various presentation tools found in MimioStudio Tools to focus your audience on a specific area of the screen by displaying only certain parts of the screen. And, you can annotate the screen with the drawing tools available in MimioStudio Tools using the Screen Annotation feature.

## Using the MimioTeach Stylus

In Interactive mode, the MimioTeach stylus can be used to control your desktop and interact with applications on your computer from your whiteboard.

The following table describes how to use the MimioTeach stylus to control your desktop from the whiteboard.

To execute	Do this
Left mouse click	Click in the projected area at the desired location with the tip of the stylus.
Double left mouse click	Quickly click twice in the projected area at the desired location with the tip of the stylus.
Right mouse click	Press the B button on the stylus, and then click in the projected area at the desired location with the tip of the stylus.
Hover	<ol style="list-style-type: none"> <li>1. Hold the stylus at the desired location, staying as close to the whiteboard as possible without touching it.</li> <li>2. Press the B button on the stylus.</li> <li>3. Move the stylus to the desired location.</li> <li>4. Release the B button on the stylus.</li> </ol>

To change the functions of the MimioTeach stylus buttons, see [Adjusting the Interactive Settings](#).

## Focusing Attention Using the Reveal and Spotlight Tools



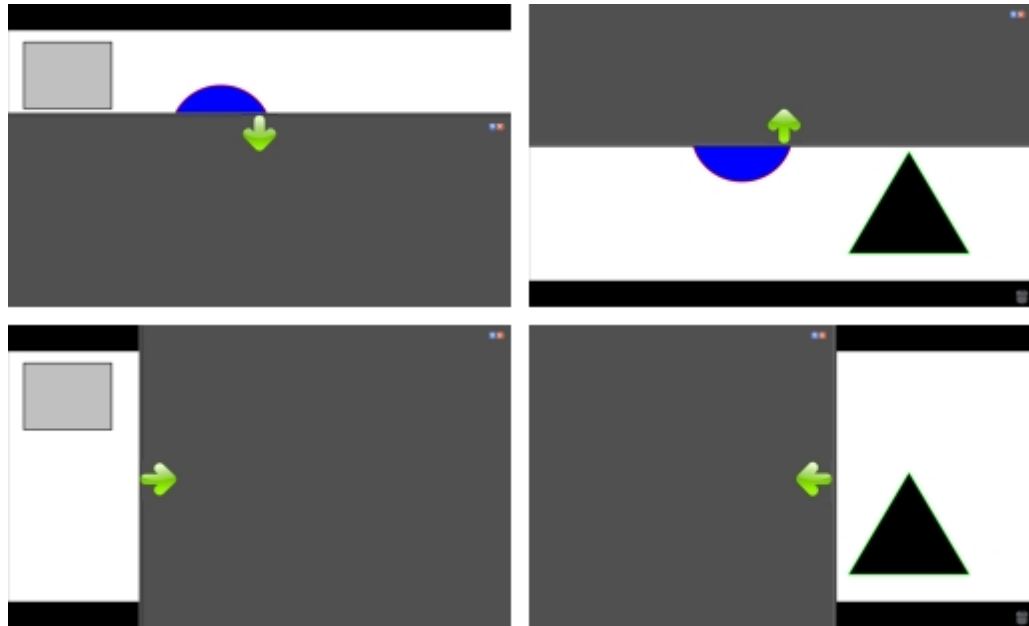

The Reveal tool and the Spotlight tool help you to focus your audience on a specific area of the screen by keeping parts of the screen hidden.

### Using the Reveal Tool

The Reveal tool creates a *shade* that you can raise, lower, move left, and move right over the screen image, as if you are moving a shade up, down, or across the screen. You can then expose bullet points or other information progressively.



#### To use the Reveal tool

- ▶ Do one of the following:
  - From MimioStudio Tools, click the **Applications** button, , and then choose  **Reveal**.
  - (*Interactive mode only*) Press the **Launch** button, , on the MimioTeach bar, and then click  **Reveal** in the Launch window.

#### To adjust the revealed area

- ▶ Click inside the shaded area and drag down, up, left, or right to reveal more or less of the displayed area.

#### To adjust the transparency of the Reveal tool

1. Click , and then point to **Transparent**.
2. From the **Transparent** list, choose a percentage.





A transparency of 0% means that the shaded area will be completely opaque.

### Using the Spotlight Tool

The Spotlight tool masks the entire screen except for a small area, the spotlight. You can then focus audience attention on a specific area of the screen. The spotlight area can be reshaped, resized, and moved around the screen.





### To use the Spotlight tool

- Do one of the following:
  - From MimioStudio Tools, click the **Applications** button, , and then choose  **Spotlight**.
  - (Interactive mode only)* Press the **Launch** button, , on the MimioTeach bar, and then click  **Spotlight** in the Launch window.
- Click the shaded area outside of the spotlight border and drag the spotlight to the desired location.

### To adjust the shape of the spotlight

- Click , and then point to **Shape**.
- From the **Shape** list, choose a shape for the spotlight.

### To resize the spotlight

- Click , and then point to **Size**.
  - From the **Size** list, choose a spotlight size.
-  You can also resize the spotlight by dragging the colored border of the spotlight until the spotlight is the desired size.

### To adjust the spotlight transparency

- Click , and then point to **Transparent**.
- From the **Transparent** list, choose a transparency percentage.  
A transparency of 0% means that the shaded area will be completely opaque.



## Marking Up the Display Using Screen Annotations

Screen Annotation mode allows you to annotate applications, web pages, and images. When in Annotation mode, a green border with a faded edge appears around your desktop.

When you exit from Screen Annotation mode, all annotations are cleared from the whiteboard and automatically archived in the Screen Annotations folder in MimioStudio Gallery.



### Enabling Screen Annotation Mode

#### To enable Screen Annotation mode



1. Do one of the following
  - From MimioStudio Tools, click the **Screen Annotation** button, , to freeze your current desktop image.
  - *(Interactive mode Only)* Press the **Launch** button, , on the MimioTeach bar, and then click  **Screen Annotation** in the Launch window.A green border with a faded edge appears around your desktop.
2. Annotate the screen using MimioStudio Tools.

All object, drawing, and manipulation features in MimioStudio Tools are available in Screen Annotation mode.

#### To exit Screen Annotation mode

- ▶ Do one of the following:
- From MimioStudio Tools, click the **Mouse** button, , to “unfreeze” the screen.
  - *(Interactive mode only)* Press the **Launch** button, , on the MimioTeach bar, and then click  **Screen Annotation** in the Launch window.

#### To disable the Annotation mode border

1. Right-click  in the notification area of the taskbar and choose  **Settings**.
2. Select  **Notebook** from the **MimioStudio Settings** dialog box.
3. Under **General**, clear the **Enable fullscreen border (Screen Annotation only)** check box.
4. Click **OK** to save the settings.

### Annotating the Screen Using MimioStudio Tools





MimioStudio Tools are used to annotate the screen. All object, drawing, and manipulation features in MimioStudio Tools are available in Screen Annotation mode.

Once you select a drawing tool, that tool remains selected until you select a different drawing tool or the selection tool.





See Manipulating Objects for a complete description of manipulating objects.

All of the functions and features of the MimioStudio drawing tools that are available in MimioStudio Notebook are available in Screen Annotation mode.



#### To use the freehand pen

1. Click the **Pen** button, .
2. (Optional) To adjust the line width, drag the Thickness slider.
3. (Optional) To adjust the line color, do one of the following:
  - Select a color from the Color Palette.
  - Click , and then select a color from the **Color** dialog box.
  - Click , and then select a color from the desktop.
4. (Optional) To adjust the transparency of the line, click the **Transparency** button, , and then choose a transparency percentage.
5. Place the cursor where you want the ink stroke to start on the page.
6. Drag the cursor to draw ink strokes.

#### To use the freehand brush

1. Click the **Brush** button, .
2. (Optional) To adjust the line width, drag the Thickness slider.
3. (Optional) To adjust the line color, do one of the following:
  - Select a color from the Color Palette.
  - Click , and then select a color from the **Color** dialog box.
  - Click , and then select a color from the desktop.
4. (Optional) To adjust the transparency of the line, click the **Transparency** button, , and then choose a transparency percentage.
5. Place the cursor where you want the brush stroke to start on the page.
6. Drag the cursor to draw brush strokes.







#### To highlight a portion of the display

1. Click the **Highlighter** button, .
2. (Optional) To adjust the highlighter width, drag the Thickness slider.
3. (Optional) To change the color, do one of the following:
  - Select a color from the Color Palette.
  - Click , and then select a color from the **Color** dialog box.
  - Click , and then select a color from the desktop.
4. Place the cursor where you want the highlight stroke to start on the page.
5. Drag the cursor over the area you want to highlight.

#### To erase ink and highlighting

1. Click the **Eraser** button, .
2. (Optional) To adjust the eraser width, drag the Thickness slider.
3. Drag the cursor over the ink or highlighter strokes you want to erase.

#### To add a line or shape

1. Click the line type or shape you want to add.
2. (Optional) To adjust the line or outline width, drag the Thickness slider.
3. (Optional) To change the line or outline color, select the Outline Color box, and then do one of the following:
  - Select a color from the Color Palette.
  - Click , and then select a color from the **Color** dialog box.
  - Click , and then select a color from the desktop.
4. (Optional) To adjust the fill color, select the Fill Color box, and then do one of the following:
  - Select a color from the Color Palette.
  - Click , and then select a color from the **Color** dialog box.
  - Click , and then select a color from the desktop.
5. To change the line or outline style, click  and choose one of the following:
  -  **Solid Line**
  -  **Dash Line**











-  **Dotted Line**

6. (Optional) To adjust the transparency of the line or shape, click the **Transparency** button, , and then choose a transparency percentage.
7. Place the cursor where you want the line or shape to start on the page.
8. Drag the cursor to draw the line or shape.

**To add formatted text**

1. Click the **Text** button, .
2. Place the cursor where you want the text to start on the page.  
For a fixed width text box, place the cursor where you want the text box to start on the page and then drag to the desired width.
3. Select a font style, size, color, and an alignment option for the text.
4. Enter text in the text box.

**To draw a shape**

1. Click the **Shape Recognition** button, .
  2. (Optional) To adjust the outline width, drag the Thickness slider.
  3. (Optional) To change the outline color, select the Outline Color box, and then do one of the following:
    - Select a color from the Color Palette.
    - Click , and then select a color from the **Color** dialog box.
    - Click , and then select a color from the desktop.
  4. (Optional) To adjust the fill color, select the Fill Color box, and then do one of the following:
    - Select a color from the Color Palette.
    - Click , and then select a color from the **Color** dialog box.
    - Click , and then select a color from the desktop.
  5. To change the line or outline style, click  and choose one of the following:
    -  **Solid Line**
    -  **Dash Line**
    -  **Dotted Line**
  6. (Optional) To adjust the transparency of the shape, click the **Transparency** button, , and then choose a transparency percentage.
  7. Place the cursor where you want the shape to start on the page.
  8. Drag the cursor to draw the shape.
-  The Shape Recognition tool can be used to draw circles, ellipses, triangles, rectangles, squares, and lines.

**Clearing All Annotations from the Display**

When you exit Screen Annotation mode, all annotations are cleared from the display and all annotations are automatically preserved as a snapshot of the display. See Working with Saved Annotation Snapshots for information about reviewing and using the snapshots.











## Inserting Text Into an Application Using MimioStudio Text Tools

You can enter text into any text-entry box or page using the MimioStudio Text Tools. The Text Tool has three modes for entering text:





- On-Screen Keyboard allows you to enter text through an on-screen keyboard application.
- Write Anywhere allows you to enter text by writing anywhere on the screen. Your handwriting is automatically converted into text and entered into the current application.
  -  Write Anywhere is only available on Windows XP 32-bit.
- Writing Pad allows you to enter text through a small on-screen writing pad. Your handwriting is automatically converted into text and input into the current application.

In addition, Write Anywhere and Writing Pad also support gesture recognition, which allows handwritten shortcuts to be automatically recognized as commonly used keys.

### To access MimioStudio Text Tools

1. From MimioStudio Tools, click the **Applications** button, , and then choose  **Text Tools**.
2. Right-click the **Text Tools** icon , , or  in the notification area of the Windows taskbar.
3. Choose the Text Tool that you want to use.
  -  **Keyboard** to enable the On-Screen Keyboard.
  -  **Write Anywhere** to enable Write Anywhere.
  -  **Writing Pad** to enable Writing Pad.

### To disable MimioStudio Text Tools

- ▶ Do one of the following:
  - Click the **Text Tools** icon , , or  in the notification area of the taskbar.
  - From MimioStudio Tools, click the **Applications** button, , and then choose  **Text Tools**.

## Using the On-Screen Keyboard

You can enter text into any application using the On-Screen Keyboard.

### To use the On-Screen Keyboard

1. Start the On-Screen Keyboard.
2. Click in the text-entry box or on the page where you want to enter the text.
3. Using your mouse or MimioTeach stylus, press the virtual keys on the on-screen keyboard.

The text is entered into the text-entry box or on the page that you selected.





## Using Write Anywhere

With Write Anywhere you can enter text into any text-entry box or page, by writing anywhere on the screen with the MimioTeach stylus while in Interactive mode. You can also use Write Anywhere with your mouse or other input device from your computer.

-  Write Anywhere is only available on Windows XP 32-bit.

#### To use Write Anywhere

1. Start Write Anywhere.  
The Write Anywhere on-screen buttons appear.
2. Click in the text-entry box or on the page where you want to enter the text.
3. Using your mouse or MimioTeach stylus, write anywhere on the screen.  
Your handwriting is automatically converted to text and entered into the text-entry box or on the page that you selected.
4. Use the on-screen buttons for commonly used keys.

Button	Description
	Backspace
	Enter
	Tab
	Space





Write Anywhere also supports gesture recognition for commonly used keys. See Using Gesture Recognition.

### Using Writing Pad

With Writing Pad you can enter text through a small on-screen writing pad using the MimioTeach stylus while in Interactive mode. You can also use Writing Pad with your mouse or other input device from your computer.

#### To use Writing Pad

1. Start Writing Pad.  
The on-screen writing pad appears.
2. Click in the text-entry box or on the page where you want to enter the text.
3. Using your mouse or MimioTeach stylus, write within the yellow space of the on-screen writing pad.  
Your handwriting is automatically converted to text and entered into the text-entry box or on the page that you selected.
4. Use the on-screen buttons for commonly used keys.



Button	Description
	Backspace
	Enter
	Tab
	Space

Writing Pad also supports gesture recognition for commonly used keys. See Using Gesture Recognition.

### Using Gesture Recognition

With gesture recognition, handwritten shortcuts are automatically recognized as commonly used keys. Both Write Anywhere and Writing Pad support gesture recognition.

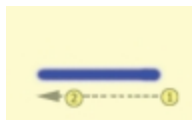

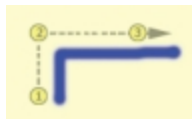
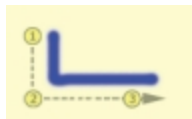

The following table describes how to use gestures to perform common functions.

To press	Do this	
Backspace	Draw a line from right to left.	
Enter	Draw a connected line from top to bottom and then from right to left.	
Tab	Draw a connected line from bottom to top and then from left to right.	
Space bar	Draw a connected line from top to bottom and then from left to right.	

### Using the Web Browser, Calculator, and Magnify Tools

MimioStudio Tools includes shortcuts for accessing a Web browser, a calculator, and a magnifier.

#### To use the tools

1. Start MimioStudio Tools.
2. Click the **Applications** button, , choose **More Tools**, and then choose one of the following tools:
  -  Calculator
  -  Magnify
  -  Web Browser

### Recording Desktop Actions and Audio in Interactive Mode

Using MimioStudio Recorder, you can record your interactions into an AVI movie file, with or without audio. See Using MimioStudio Recorder for more information on how to use MimioStudio Recorder.

## Caring for MimioTeach

---

Review the following topics for information about cleaning, inserting the batteries, and permanently mounting your MimioTeach.

- Cleaning MimioTeach
- Inserting the Batteries
- Mounting MimioTeach to a Non-Magnetic Whiteboard

### Cleaning MimioTeach

MimioTeach is designed to give you long and trouble-free service while requiring very little maintenance.

You can easily clean your MimioTeach using the following items:

- Lint-free cloth.
- Isopropyl alcohol, diluted dishwashing detergent, or diluted glass cleaner.  
 If you use glass cleaner, make sure it does not contain ammonia.

#### To clean the MimioTeach bar and stylus

1. Disconnect the USB cable from the MimioTeach bar.
2. Use the lint-free cloth to wipe the exterior of the MimioTeach bar and stylus.
3. Remove dirt and smudges with one of the cleaning solutions mentioned above.  
 Avoid using liquids on any exposed charging contacts. Do not allow liquid into any openings on the equipment.
4. Reconnect the USB cable.

### Inserting the Batteries

MimioTeach is powered using the included USB cable and power adapter. Optionally, MimioTeach can be powered using three AAA batteries.

#### To insert the batteries

1. Press down and slide off the battery compartment cover.
  2. Insert three AAA batteries into the battery compartment.
  3. Replace the battery compartment cover.
-  Remove the batteries if the MimioTeach bar will not be used for a long period of time.

### Mounting MimioTeach to a Non-Magnetic Whiteboard

The MimioTeach bar attaches securely to any magnetic whiteboard. If you do not have a magnetic whiteboard, you can mount the MimioTeach bar to your whiteboard using the included metal plates.

-  If you are installing both MimioTeach and MimioCapture, you must mount MimioCapture before mounting MimioTeach. This will ensure proper placement of the MimioTeach bar. See Mounting MimioCapture to a Non-Magnetic Whiteboard for information on mounting MimioCapture.

#### To mount MimioTeach to a non-magnetic whiteboard

1. Place the metal plates against the back of the MimioTeach bar as shown.  
Make sure that the recess on each plate is inserted into the recess on the back of the MimioTeach bar.

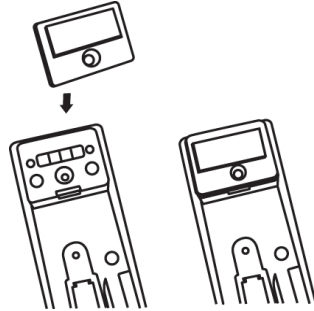

2. Remove the paper backing from the adhesive strips to expose the adhesive.

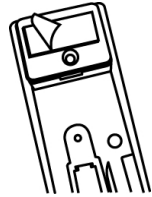

3. Press the MimioTeach bar firmly along the left edge of the whiteboard as shown.

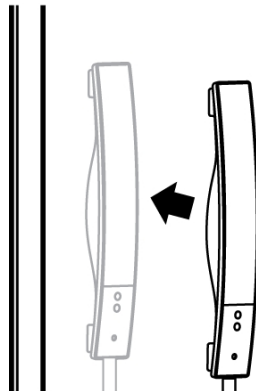

This page intentionally left blank for double-sided printing.

## Chapter 4

# Mimio Interactive

Using Mimio Interactive with a projector, you can deliver lessons and presentations directly from your whiteboard. Using MimioStudio Interactive mode, you control the movement of the cursor on your screen with the Mimio Interactive Mouse, much like you would with a mouse at your computer.

### What's Included

The Mimio Interactive package contains the following items:

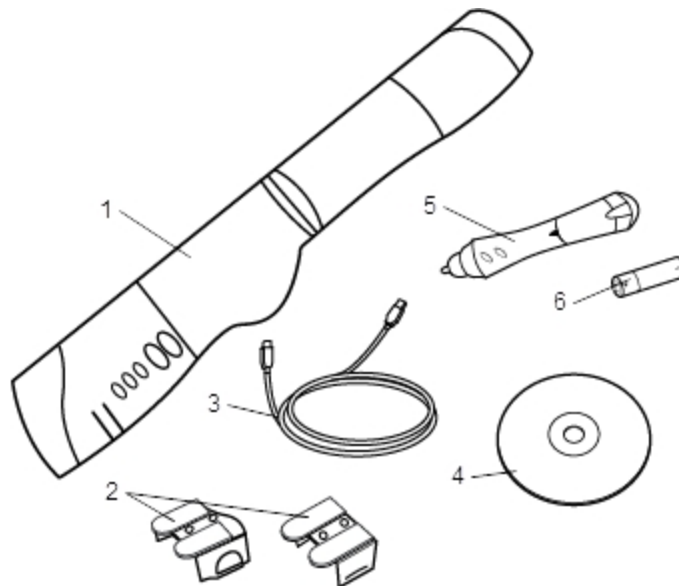

1	Mimio Interactive bar	4	MimioStudio DVD
2	Mounting brackets	5	Mimio mouse
3	USB cable	6	AA battery

If you are missing any of the items above, contact Customer Support.

### About Mimio Interactive

You can use the Mimio Interactive bar and mouse in MimioStudio Interactive mode to deliver lessons and presentations.

You can also use the Mimio Interactive bar with Mimio Capture Kit to capture notes from your whiteboard into MimioStudio Notebook. For more information about using Mimio

Interactive with Mimio Capture Kit, see Mimio Capture Kit.

The following figure shows the major components of Mimio Interactive.

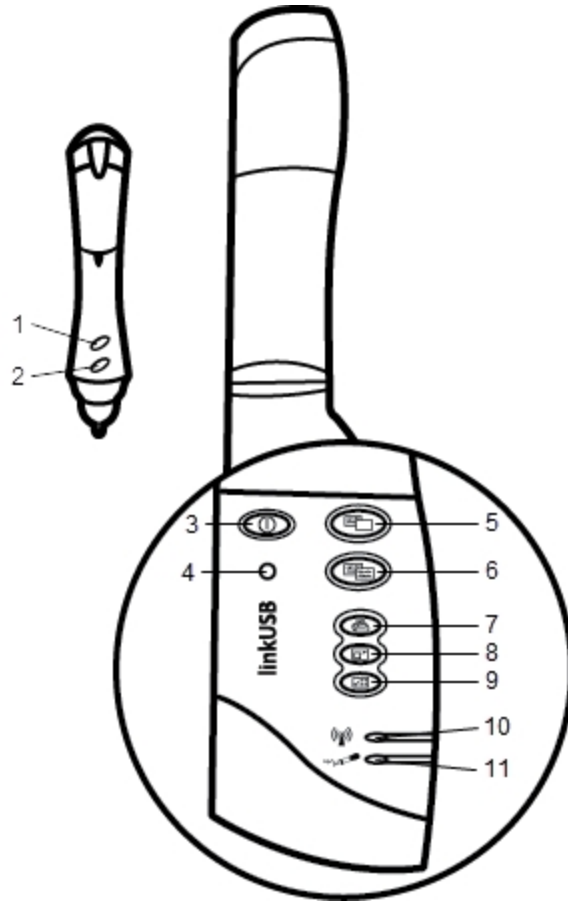

1	A button (right-click)	7	Print page (Spotlight tool)
2	B button (hover)	8	Resize window (Reveal tool)
3	Power button/status light	9	Interactive
4	Learning button	10	Data transmission status light
5	New page (MimioStudio Tools)	11	Memory status light
6	Copy page (Annotation mode)		

### Status Lights

The status lights visually show the status of the Mimio Interactive bar.

#### Power Status Lights

Off	Not receiving power; USB/power cable is not connected, batteries need replaced,
-----	---



---

	or Mimio Interactive is turned off.
Solid Green	Mimio Interactive is receiving power.
Solid Amber	Mimio Interactive is receiving power; one to five hours of battery life remaining.
Flashing Amber	Mimio Interactive is receiving power; less than one hour of battery life remaining.

#### **Data Transmission Status Lights**

Off	Mimio Capture Kit pen or Mimio Interactive mouse is not in use.
Solid Green	Mimio Capture Kit pen or Mimio Interactive mouse is in use.
Solid Amber	Mimio Capture Kit pen or Mimio Interactive mouse battery is low.

#### **Memory Status Lights**

Off	Mimio Interactive bar memory is empty.
Flashing Green	Data is being downloaded from the Mimio Interactive bar to your computer.
Solid Green	Mimio Interactive bar memory is less than 80% full.
Solid Amber	Mimio Interactive bar memory is between 80% and 90% full.
Flashing Amber	Mimio Interactive bar memory is over 90% full.

### **About Mimio Wireless**

You can use the Mimio Wireless module and wireless receiver to connect the Mimio Interactive bar wirelessly to your computer.

The following figure shows the major components of Mimio Wireless.

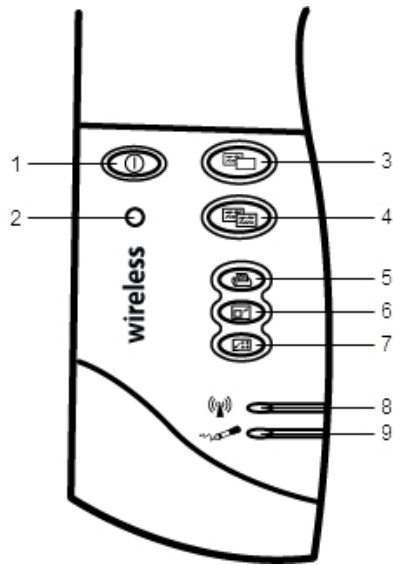

1	Power button/status light	6	Resize window (Reveal tool)
2	Learning button	7	Interactive
3	New page (MimioStudio Tools)	8	Link status light
4	Copy page (Annotation mode)	9	Data transmission status light
5	Print page (Spotlight tool)		

### Status Lights

The status lights visually show the status of the Mimio Interactive bar.

#### Power Status Lights

Off	Not receiving power; USB/power cable is not connected, batteries need replaced, or Mimio Interactive is turned off.
Solid Green	Mimio Interactive is receiving power.
Solid Amber	Mimio Interactive is receiving power; one to five hours of battery life remaining.
Flashing Amber	Mimio Interactive is receiving power; less than one hour of battery life remaining.

#### Link Status Lights

Solid Green	Mimio Interactive is connected to the wireless receiver.
Flashing Green	Mimio Interactive is establishing a connection to the wireless receiver.

---

Solid Amber	Mimio Interactive cannot find an available wireless receiver.
-------------	---

**Data Transmission Status Lights**

Flashing Green (slowly)	Mimio Capture Kit pen or Mimio Interactive mouse is not in use.
Flashing Green (quickly)	Mimio Capture Kit pen or Mimio Interactive mouse is in use.
Solid Amber	Mimio Capture Kit pen or Mimio Interactive mouse battery is low.

**About MimioStudio Tools**









With the various presentation tools found in MimioStudio Tools you can focus your audience on a specific area of the screen by displaying only certain parts of the screen. You can also annotate the screen with the drawing tools available in MimioStudio Tools using the Screen Annotation feature.

For more information about MimioStudio Tools, see [Marking Up the Display Using Screen Annotations](#).

The following table describes the major components of MimioStudio Tools.

	Selection tool		Zoom
	Pen		Brush
	Text		Highlighter
	Line		Arrow End
	Arrow Start		Arrow Both
	Rectangle		Ellipse
	Triangle		Right Triangle
	Five Pointed Star		Hexagon
	Pentagon		Shape Recognition
	Eraser		Insert file
	Screen clipping		Color picker
	More colors		Object Fill
	Outline and Fill color		Thickness slider
	Color palette		Solid Line
	Dash Line		Dotted Line
	Transparency		Gallery
	Applications (see below)		Right-click
	Interactive		Mouse
	Screen Annotation		

From the Applications tool, you can access the following:

- |  |  |  |
|--|--|--|
|  Reveal     |  Quick Vote |  Calculator  |
|  Spotlight  |  Recorder   |  Magnify     |
|  Text Tools |  View       |  Web Browser |

---

## Getting Started

---

Review the following topics to install and start using your Mimio Interactive.

- Setting Up the Mimio InteractiveMouse
- Setting Up the Mimio Interactive Bar
- Setting Up Mimio Wireless
- Setting Up Interactive Mode

### Setting Up the Mimio Interactive Mouse

The Mimio Interactive Mouse is powered by one AA battery.

#### To set up the Mimio Interactive Mouse

1. Press down and slide off the battery compartment cover.

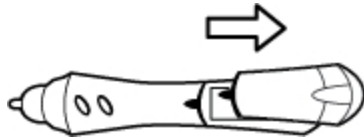

2. Insert one AA battery into the battery compartment.

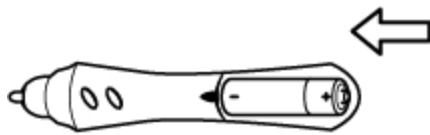

3. Replace the battery compartment cover.

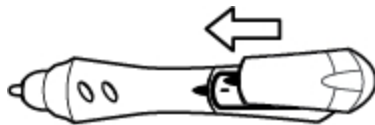

### Setting Up the Mimio Interactive Bar

Mimio Interactive is powered through your computer using the included USB cable.

- Optionally, Mimio Interactive can be powered using four AA batteries. For information about using batteries to power the Mimio Interactive bar, see Inserting the Batteries.

#### To set up the Mimio Interactive bar

1. Unfold the Mimio Interactive bar.



2. Plug the USB cable into the USB port on the Mimio Interactive bar.

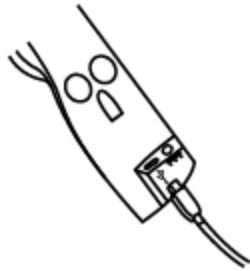

3. Plug the other end of the USB cable into an available USB port on your computer.
4. Place the Mimio Interactive bar along the left edge of the whiteboard as shown.

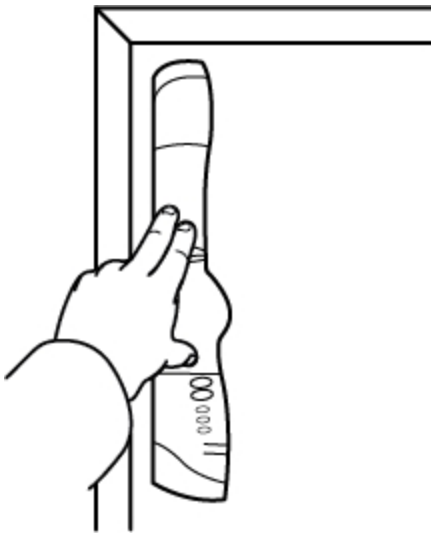

The Mimio Interactive bar attaches to any whiteboard using the suction cups on the back of the bar.

- If the Mimio Interactive bar will be used for extended periods of time or will be used repeatedly in any one location, you should mount the bar using the included brackets. See Mounting the Mimio Capture Kit for information about mounting the bar using the brackets.

## Setting Up Mimio Wireless

The Mimio Wireless module comes pre-linked to the included wireless receiver.

Mimio Interactive bar is powered using the included power adapter.

- Optionally, Mimio Interactive can be powered using four AA batteries. For information about using batteries to power the Mimio Interactive bar, see Inserting the Batteries.

### To set up Mimio Wireless

1. Press the release button on the back of the Mimio Interactive bar, and then slide the linkUSB module down to remove.

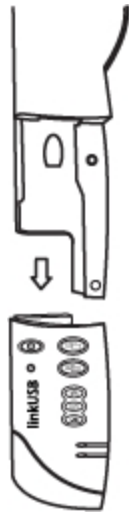

2. Slide the Mimio Wireless module onto the Mimio Interactive bar.

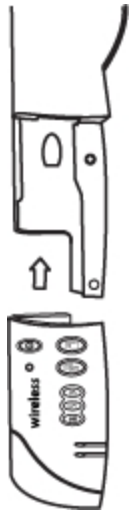

3. Plug the power adapter into the power connector on the bottom of the Mimio Interactive bar.



4. Plug the other end of the power adapter into a power outlet.
5. Place the Mimio Interactive bar along the left edge of the whiteboard as shown.



The Mimio Interactive bar attaches to any whiteboard using the suction cups on the back of the bar.

6. Plug the wireless receiver into an available USB port on your computer.

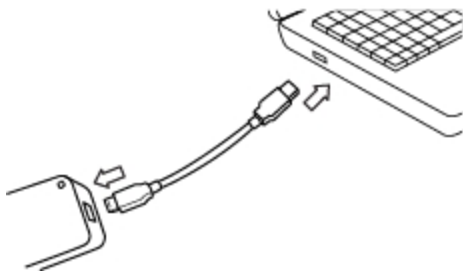

- If the Mimio Interactive bar will be used for extended periods of time or will be used repeatedly in any one location, you should mount the bar using the included brackets. See *Mounting the Mimio Capture Kit* for information about mounting the bar using the brackets.

## Setting Up Interactive Mode

Using MimioStudio Interactive mode, you can deliver lessons and presentations directly from your whiteboard.

To use Interactive mode you need a projector, a Mimio Interactive-enabled whiteboard, and a Mimio Interactive Mouse. Combined, these devices make for a powerful tool for delivering lessons and presentations.

## Projecting Your Desktop

If you are presenting from a MimioStudio Notebook or another application, such as a PowerPoint presentation, you can open the application before or after Interactive mode is enabled and calibrated.

### To start Interactive mode



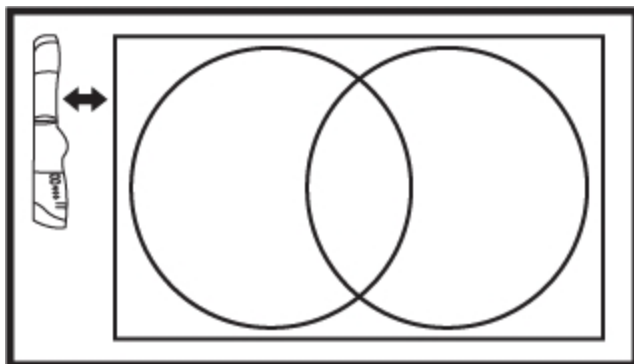

1. Project your desktop image onto your whiteboard.  
Refer to your projector's documentation for instructions on how to project your desktop image.
2. Adjust the projected image to have a 2-inch to 3-inch buffer between the edge of your projection and your Mimio Interactive.



3. Click the Mimio Interactive Mouse anywhere on the whiteboard.  
Interactive mode starts and the calibration screen appears.

#### To exit Interactive mode



- ▶ Do one of the following:
  - Press the **Interactive** button, , twice on the Mimio Interactive bar.
  - Start MimioStudio Tools, click **Interactive** , and then click **Exit**.
  - Start MimioStudio Settings, select **Interactive**, and then click **Disable**.  
See Customizing MimioStudio for information on how to access MimioStudio Settings.

### Calibrating Interactive Mode

Each time Interactive mode is enabled, you are prompted to calibrate using the Mimio Interactive Mouse.

When using a permanently installed whiteboard and projector, you do not need to recalibrate Interactive mode after the first session. See Adjusting the Interactive Settings.

#### To calibrate Interactive mode

1. If the calibration screen does not appear when you start Interactive mode, do one of the following:
  - Press the **Interactive** button, , on your Mimio Interactive bar.
  - Start MimioStudio Tools, click the **Interactive** button, , and then click **Recalibrate**.
  - Start MimioStudio Settings, select **Interactive**, and then click **Calibrate**.
2. Press the Mimio Interactive Mouse down on the whiteboard at the center of each of the nine calibration targets.

Make sure to hold the stylus perpendicular to the writing surface as you click.

The calibration target disappears and the next calibration target appears.

When the calibration screen disappears, Interactive mode is enabled.

## Using Mimio Interactive

---

You can use the Mimio Interactive bar and stylus in MimioStudio Interactive mode to deliver lessons and presentations. In MimioStudio Interactive mode, you control the movement of the cursor on your screen with the Mimio Interactive Mouse, much like you would with a mouse at your computer.

You can also use the various presentation tools found in MimioStudio Tools to focus your audience on a specific area of the screen by displaying only certain parts of the screen. And, you can annotate the screen with the drawing tools available in MimioStudio Tools using the Screen Annotation feature.

### Using the Mimio Interactive Mouse

In Interactive mode, the Mimio Interactive Mouse can be used to control your desktop and interact with applications on your computer from your whiteboard.

The following table describes how to use the Mimio Interactive Mouse to control your desktop from the whiteboard.

To execute	Do this
Left mouse click	Click in the projected area at the desired location with the tip of the Mimio Interactive Mouse.
Double left mouse click	Quickly click twice in the projected area at the desired location with the tip of the Mimio Interactive Mouse.
Right mouse click	<ol style="list-style-type: none"><li>1. Hold the Mimio Interactive Mouse at the desired location, staying as close to the whiteboard as possible without touching it.</li><li>2. Press the A (concave) button on the Mimio Interactive Mouse.</li></ol>
Hover	<ol style="list-style-type: none"><li>1. Hold the Mimio Interactive Mouse at the desired location, staying as close to the whiteboard as possible without touching it.</li><li>2. Press the B (convex) button on the Mimio Interactive Mouse.</li><li>3. Move the Mimio Interactive Mouse to the desired location.</li><li>4. Release the B button on the Mimio Interactive Mouse.</li></ol>

To change the functions of the Mimio Interactive Mouse buttons, see [Adjusting the Interactive Settings](#).

### Focusing Attention Using the Reveal and Spotlight Tools



The Reveal tool and the Spotlight tool help you to focus your audience on a specific area of the screen by keeping parts of the screen hidden.

#### Using the Reveal Tool

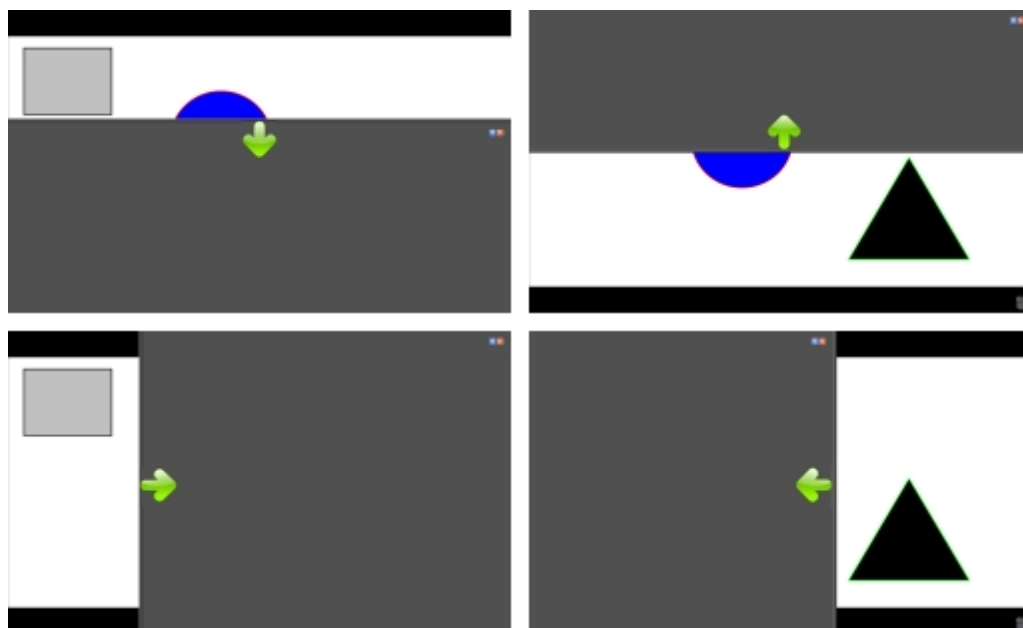
The Reveal tool creates a *shade* that you can raise, lower, move left, and move right over the screen image, as if you are moving a shade up, down, or across the screen. You can then expose bullet points or other information progressively.



#### To use the Reveal tool

- ▶ Do one of the following:
  - From MimioStudio Tools, click the **Applications** button, , and then choose  **Reveal**.
  - (*Interactive mode only*) Press the **Resize window** button, , on the Mimio Interactive bar.

#### To adjust the revealed area

- ▶ Click inside the shaded area and drag down, up, left, or right to reveal more or less of the displayed area.

#### To adjust the transparency of the Reveal tool



1. Click , and then point to **Transparent**.
2. From the **Transparent** list, choose a percentage.
  - A transparency of 0% means that the shaded area will be completely opaque.

### Using the Spotlight Tool

The Spotlight tool masks the entire screen except for a small area, the spotlight. You can then focus audience attention on a specific area of the screen. The spotlight area can be reshaped, resized, and moved around the screen.





#### To use the Spotlight tool

- Do one of the following:
  - From MimioStudio Tools, click the **Applications** button, , and then choose  **Spotlight**.
  - (Interactive mode only)* Press the **Print page** button, , on the Mimio Interactive bar.
- Click the shaded area outside of the spotlight border and drag the spotlight to the desired location.

#### To adjust the shape of the spotlight

- Click , and then point to **Shape**.
- From the **Shape** list, choose a shape for the spotlight.

#### To resize the spotlight

- Click , and then point to **Size**.
  - From the **Size** list, choose a spotlight size.
-  You can also resize the spotlight by dragging the colored border of the spotlight until the spotlight is the desired size.

#### To adjust the spotlight transparency

- Click , and then point to **Transparent**.
- From the **Transparent** list, choose a transparency percentage.  
A transparency of 0% means that the shaded area will be completely opaque.



## Marking Up the Display Using Screen Annotations

Screen Annotation mode allows you to annotate applications, web pages, and images. When in Annotation mode, a green border with a faded edge appears around your desktop.

When you exit from Screen Annotation mode, all annotations are cleared from the whiteboard and automatically archived in the Screen Annotations folder in MimioStudio Gallery.



### Enabling Screen Annotation Mode

#### To enable Screen Annotation mode



1. Do one of the following
    - From MimioStudio Tools, click the **Screen Annotation** button, , to freeze your current desktop image.
    - *(Interactive mode Only)* Press the **Copy page** button, , on the Mimio Interactive bar.

A green border with a faded edge appears around your desktop.
  2. Annotate the screen using MimioStudio Tools.
- All object, drawing, and manipulation features in MimioStudio Tools are available in Screen Annotation mode.

#### To exit Screen Annotation mode

- ▶ Do one of the following:
  - From MimioStudio Tools, click the **Mouse** button, , to “unfreeze” the screen.
  - *(Interactive mode Only)* Press the **Copy page** button, , on the Mimio Interactive bar.

#### To disable the Annotation mode border

1. Right-click  in the notification area of the taskbar and choose  **Settings**.
2. Select  **Notebook** from the **MimioStudio Settings** dialog box.
3. Under **General**, clear the **Enable fullscreen border (Screen Annotation only)** check box.
4. Click **OK** to save the settings.

### Annotating the Screen Using MimioStudio Tools





MimioStudio Tools are used to annotate the screen. All object, drawing, and manipulation features in MimioStudio Tools are available in Screen Annotation mode.

Once you select a drawing tool, that tool remains selected until you select a different drawing tool or the selection tool.





See *Manipulating Objects* for a complete description of manipulating objects.

All of the functions and features of the MimioStudio drawing tools that are available in MimioStudio Notebook are available in Screen Annotation mode.



#### To use the freehand pen

1. Click the **Pen** button, .
2. (Optional) To adjust the line width, drag the Thickness slider.
3. (Optional) To adjust the line color, do one of the following:
  - Select a color from the Color Palette.
  - Click , and then select a color from the **Color** dialog box.
  - Click , and then select a color from the desktop.
4. (Optional) To adjust the transparency of the line, click the **Transparency** button, , and then choose a transparency percentage.
5. Place the cursor where you want the ink stroke to start on the page.
6. Drag the cursor to draw ink strokes.

#### To use the freehand brush

1. Click the **Brush** button, .
2. (Optional) To adjust the line width, drag the Thickness slider.
3. (Optional) To adjust the line color, do one of the following:
  - Select a color from the Color Palette.
  - Click , and then select a color from the **Color** dialog box.
  - Click , and then select a color from the desktop.
4. (Optional) To adjust the transparency of the line, click the **Transparency** button, , and then choose a transparency percentage.
5. Place the cursor where you want the brush stroke to start on the page.
6. Drag the cursor to draw brush strokes.







#### To highlight a portion of the display

1. Click the **Highlighter** button, .
2. (Optional) To adjust the highlighter width, drag the Thickness slider.
3. (Optional) To change the color, do one of the following:
  - Select a color from the Color Palette.
  - Click , and then select a color from the **Color** dialog box.
  - Click , and then select a color from the desktop.
4. Place the cursor where you want the highlight stroke to start on the page.
5. Drag the cursor over the area you want to highlight.

#### To erase ink and highlighting

1. Click the **Eraser** button, .
2. (Optional) To adjust the eraser width, drag the Thickness slider.
3. Drag the cursor over the ink or highlighter strokes you want to erase.

#### To add a line or shape

1. Click the line type or shape you want to add.
2. (Optional) To adjust the line or outline width, drag the Thickness slider.
3. (Optional) To change the line or outline color, select the Outline Color box, and then do one of the following:
  - Select a color from the Color Palette.
  - Click , and then select a color from the **Color** dialog box.
  - Click , and then select a color from the desktop.
4. (Optional) To adjust the fill color, select the Fill Color box, and then do one of the following:
  - Select a color from the Color Palette.
  - Click , and then select a color from the **Color** dialog box.
  - Click , and then select a color from the desktop.
5. To change the line or outline style, click  and choose one of the following:
  -  **Solid Line**
  -  **Dash Line**











-  **Dotted Line**

6. (Optional) To adjust the transparency of the line or shape, click the **Transparency** button, , and then choose a transparency percentage.
7. Place the cursor where you want the line or shape to start on the page.
8. Drag the cursor to draw the line or shape.

#### To add formatted text

1. Click the **Text** button, .
2. Place the cursor where you want the text to start on the page.  
For a fixed width text box, place the cursor where you want the text box to start on the page and then drag to the desired width.
3. Select a font style, size, color, and an alignment option for the text.
4. Enter text in the text box.

#### To draw a shape

1. Click the **Shape Recognition** button, .
  2. (Optional) To adjust the outline width, drag the Thickness slider.
  3. (Optional) To change the outline color, select the Outline Color box, and then do one of the following:
    - Select a color from the Color Palette.
    - Click , and then select a color from the **Color** dialog box.
    - Click , and then select a color from the desktop.
  4. (Optional) To adjust the fill color, select the Fill Color box, and then do one of the following:
    - Select a color from the Color Palette.
    - Click , and then select a color from the **Color** dialog box.
    - Click , and then select a color from the desktop.
  5. To change the line or outline style, click  and choose one of the following:
    -  **Solid Line**
    -  **Dash Line**
    -  **Dotted Line**
  6. (Optional) To adjust the transparency of the shape, click the **Transparency** button, , and then choose a transparency percentage.
  7. Place the cursor where you want the shape to start on the page.
  8. Drag the cursor to draw the shape.
-  The Shape Recognition tool can be used to draw circles, ellipses, triangles, rectangles, squares, and lines.

### Clearing All Annotations from the Display

When you exit Screen Annotation mode, all annotations are cleared from the display and all annotations are automatically preserved as a snapshot of the display. See *Working with Saved Annotation Snapshots* for information about reviewing and using the snapshots.









## Inserting Text Into an Application Using MimioStudio Text Tools

You can enter text into any text-entry box or page using the MimioStudio Text Tools. The Text Tool has three modes for entering text:





- On-Screen Keyboard allows you to enter text through an on-screen keyboard application.
- Write Anywhere allows you to enter text by writing anywhere on the screen. Your handwriting is automatically converted into text and entered into the current application.
  -  Write Anywhere is only available on Windows XP 32-bit.
- Writing Pad allows you to enter text through a small on-screen writing pad. Your handwriting is automatically converted into text and input into the current application.

In addition, Write Anywhere and Writing Pad also support gesture recognition, which allows handwritten shortcuts to be automatically recognized as commonly used keys.

### To access MimioStudio Text Tools

1. From MimioStudio Tools, click the **Applications** button, , and then choose  **Text Tools**.
2. Right-click the **Text Tools** icon , , or  in the notification area of the Windows taskbar.
3. Choose the Text Tool that you want to use.
  -  **Keyboard** to enable the On-Screen Keyboard.
  -  **Write Anywhere** to enable Write Anywhere.
  -  **Writing Pad** to enable Writing Pad.

### To disable MimioStudio Text Tools

- ▶ Do one of the following:
  - Click the **Text Tools** icon , , or  in the notification area of the taskbar.
  - From MimioStudio Tools, click the **Applications** button, , and then choose  **Text Tools**.

## Using the On-Screen Keyboard

You can enter text into any application using the On-Screen Keyboard.

### To use the On-Screen Keyboard

1. Start the On-Screen Keyboard.
2. Click in the text-entry box or on the page where you want to enter the text.
3. Using your mouse or Mimio Interactive Mouse, press the virtual keys on the on-screen keyboard.

The text is entered into the text-entry box or on the page that you selected.

## Using Write Anywhere





With Write Anywhere you can enter text into any text-entry box or page, by writing anywhere on the screen with the Mimio Interactive Mouse while in Interactive mode. You can also use Write Anywhere with your mouse or other input device from your computer.



-  Write Anywhere is only available on Windows XP 32-bit.

### To use Write Anywhere

1. Start Write Anywhere.  
The Write Anywhere on-screen buttons appear.
2. Click in the text-entry box or on the page where you want to enter the text.
3. Using your mouse or Mimio Interactive Mouse, write anywhere on the screen.  
Your handwriting is automatically converted to text and entered into the text-entry box or on the page that you selected.
4. Use the on-screen buttons for commonly used keys.

Button	Description
	Backspace
	Enter
	Tab
	Space





Write Anywhere also supports gesture recognition for commonly used keys. See Using Gesture Recognition.

### Using Writing Pad

With Writing Pad you can enter text through a small on-screen writing pad using the Mimio Interactive Mouse while in Interactive mode. You can also use Writing Pad with your mouse or other input device from your computer.

#### To use Writing Pad

1. Start Writing Pad.  
The on-screen writing pad appears.
2. Click in the text-entry box or on the page where you want to enter the text.
3. Using your mouse or Mimio Interactive Mouse, write within the yellow space of the on-screen writing pad.  
Your handwriting is automatically converted to text and entered into the text-entry box or on the page that you selected.
4. Use the on-screen buttons for commonly used keys.





Button	Description
	Backspace
	Enter
	Tab
	Space

Writing Pad also supports gesture recognition for commonly used keys. See Using Gesture Recognition.

### Using Gesture Recognition

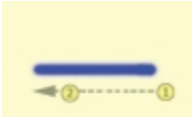
With gesture recognition, handwritten shortcuts are automatically recognized as commonly used keys. Both Write Anywhere and Writing Pad support gesture recognition.

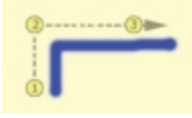



The following table describes how to use gestures to perform common functions.

To press	Do this	
Backspace	Draw a line from right to left.	
Enter	Draw a connected line from top to bottom and then from right to left.	
Tab	Draw a connected line from bottom to top and then from left to right.	
Space bar	Draw a connected line from top to bottom and then from left to right.	

### Using the Web Browser, Calculator, and Magnify Tools

MimioStudio Tools includes shortcuts for accessing a Web browser, a calculator, and a magnifier.

#### To use the tools

1. Start MimioStudio Tools.
2. Click the **Applications** button, , choose **More Tools**, and then choose one of the following tools:
  -  Calculator
  -  Magnify
  -  Web Browser

### Recording Desktop Actions and Audio in Interactive Mode

Using MimioStudio Recorder, you can record your interactions into an AVI movie file, with or without audio. See Using MimioStudio Recorder for more information on how to use MimioStudio Recorder.

## Caring for Mimio Interactive

---

Review the following topics for information about cleaning, inserting the batteries, and permanently mounting your Mimio Interactive.

- Cleaning Mimio Interactive
- Inserting the Batteries
- Mounting Mimio Interactive Permanently

### Cleaning Mimio Interactive

Mimio Interactive is designed to give you long and trouble-free service while requiring very little maintenance.

You can easily clean your Mimio Interactive using the following items:

- Lint-free cloth.
  - Isopropyl alcohol, diluted dishwashing detergent, or diluted glass cleaner.
-  If you use glass cleaner, make sure it does not contain ammonia.

#### To clean the Mimio Interactive bar and Mouse

1. If necessary, disconnect the USB cable from the Mimio Interactive bar.
2. Use the lint-free cloth to wipe the exterior of the Mimio Interactive bar and Mouse.
3. Remove dirt and smudges with one of the cleaning solutions mentioned above.

 Avoid using liquids on any exposed charging contacts. Do not allow liquid into any openings on the equipment.
4. Reconnect the USB cable.

### Inserting the Batteries

Mimio Interactive is powered using the included USB cable and power adapter. Optionally, Mimio Interactive can be powered using four AA batteries.

#### To insert the batteries

1. Press down and slide off the battery compartment cover.
  2. Insert four AA batteries into the battery compartment.
  3. Replace the battery compartment cover.
-  Remove the batteries if the Mimio Interactive bar will not be used for a long period of time.

### Mounting Mimio Interactive Permanently

The Mimio Interactive bar attaches to any whiteboard using the suction cups on the back of the bar. If the Mimio Interactive bar will be used for extended periods of time or will be used repeatedly in any one location, you should mount the bar using the included brackets.

#### To mount Mimio Interactive permanently

1. Snap the mounting brackets over the suction cups on the back of the Mimio Interactive bar.

Make sure that the brackets clip into the recesses on the sides of the Mimio Interactive bar.

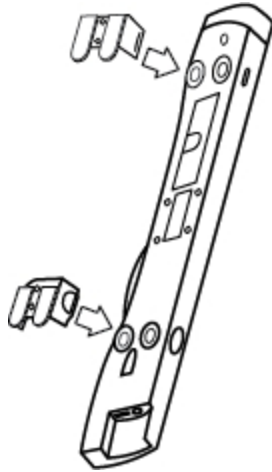

2. Remove the paper backing from the adhesive strips to expose the adhesive.



3. Press the Mimio Interactive bar firmly along the top left edge of the whiteboard as shown.

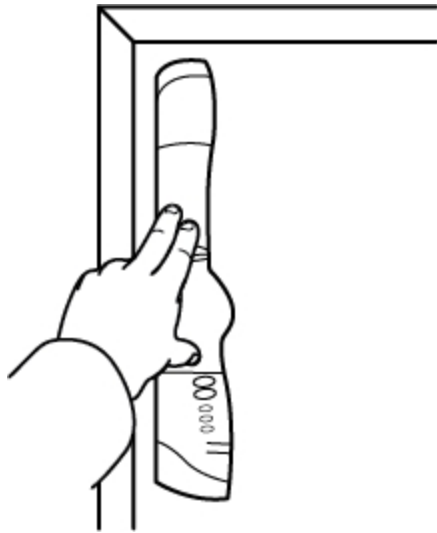

This page intentionally left blank for double-sided printing.

## Chapter 5

# MimioCapture

MimioCapture is used with a MimioTeach-enabled whiteboard to record notes and drawings from your whiteboard. Using MimioStudio Ink Capture mode, you make notes and drawings on your whiteboard using the MimioCapture pens. Your notes are automatically captured in a MimioStudio Notebook.

### What's Included

The MimioCapture package contains the following items:

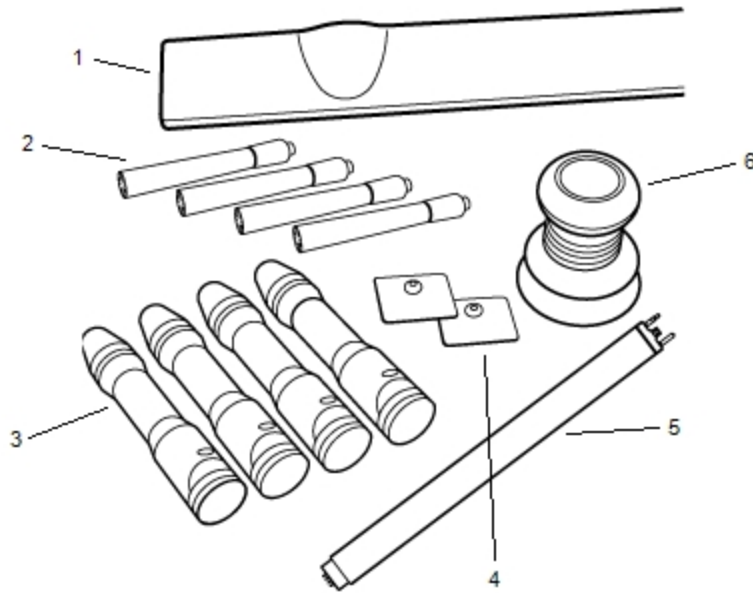

1	MimioCapture tray	4	Mounting plates
2	Expo dry erase markers (4)	5	Connector bar
3	MimioCapture pens (4)	6	MimioCapture eraser

If you are missing any of the items above, contact Customer Support.

### About MimioCapture

MimioCapture includes four pens and one eraser for making notes on your MimioTeach-enabled whiteboard. The MimioCapture tray is used to store and charge the pens and eraser. You can also perform some common actions using the buttons on the MimioCapture tray.

The following figure shows the major components of MimioCapture.

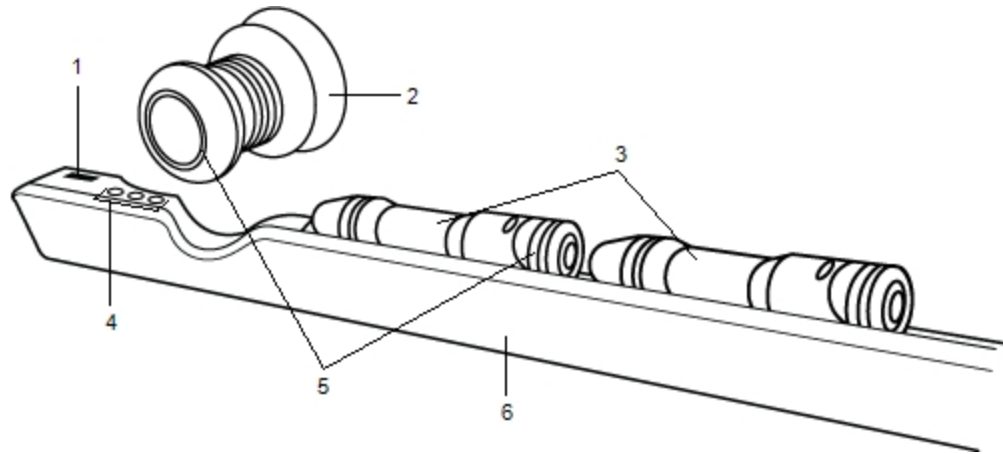

1	Connector bar port	4	Capture buttons
2	MimioCapture eraser	5	Status lights
3	MimioCapture pens	6	Charging tray

### Status Lights

The status lights visually show the status of each MimioCapture pen and the MimioCapture eraser.

Off	The MimioCapture pen or eraser is not receiving power. The status light is off when the pen or eraser is in use.
Amber	The MimioCapture pen or eraser has a low battery. The battery should be recharged.
Solid Green	The MimioCapture pen or eraser is charging.

### About MimioStudio Notebook

As you make notes on your whiteboard using MimioCapture, you can automatically save those notes into MimioStudio Notebook. Once the information is in Notebook, you can save the Notebook as a MimioStudio INK file or a variety of other formats.

For more information about using MimioStudio Notebook, see [Working with MimioStudio Notebook](#).

### Getting Started

MimioCapture links directly to your MimioTeach for seamless integration with MimioStudio software. Before you can begin capturing digital ink, you must first set up your MimioCapture tray, MimioCapture pens, MimioCapture eraser, and MimioStudio Notebook.



## Setting Up the MimioCapture Tray

The MimioCapture tray is powered using the USB cable and power adapter that were included with your MimioTeach. The MimioTeach bar connects to the MimioCapture tray using the connector bar that was included with your MimioCapture.

### To connect

1. Remove the MimioTeach bar from the whiteboard.
2. Unplug the USB cable from the MimioTeach bar.

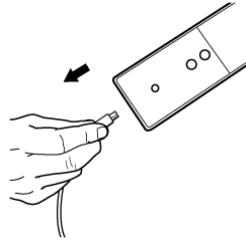

3. Plug the USB cable into the USB port on the MimioCapture tray.

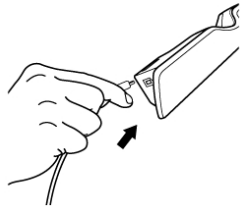

4. Place the MimioCapture tray along the bottom-left edge of the whiteboard as shown.

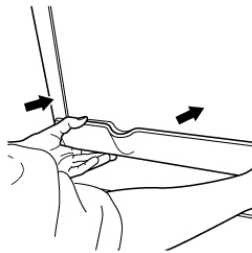

The MimioCapture tray attaches securely to any magnetic whiteboard. See [Mounting MimioCapture to a Non-Magnetic Whiteboard](#) for information about mounting the tray to a non-magnetic whiteboard.

5. Connect the connector bar to the MimioCapture tray as shown.

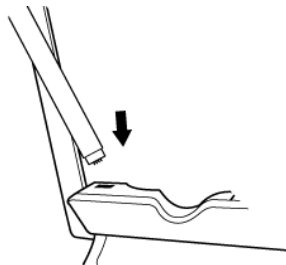

6. Connect the other end of the connector bar to the MimioTeach bar as shown.

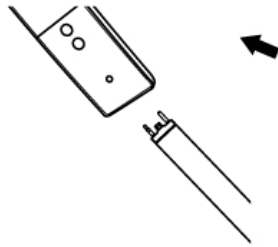

7. Reattach the MimioTeach bar along the left side of the whiteboard.

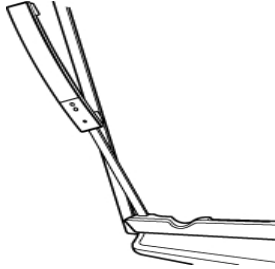

## Setting Up the MimioCapture Pens

MimioCapture comes with four colored MimioCapture pens and four Expo® dry erase markers. Before you can start using MimioCapture, you must first set up your MimioCapture Pens.

The MimioCapture pens are each powered by a rechargeable lithium-ion battery. The pens charge whenever they are docked on the MimioCapture tray.

### To set up the MimioCapture pens

1. Pull the plastic strip from the top part of the pen to activate the rechargeable battery.

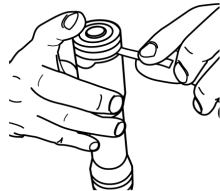

2. Press the button on the side of the pen and pull the top part of the pen from the pen body.

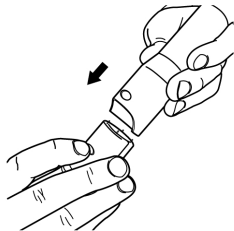

3. Insert a colored Expo® dry erase marker into the matching colored pen body.

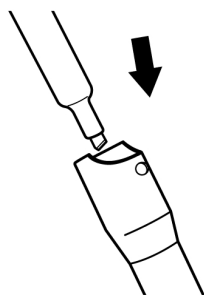

4. Replace the top part of the pen onto the pen body.

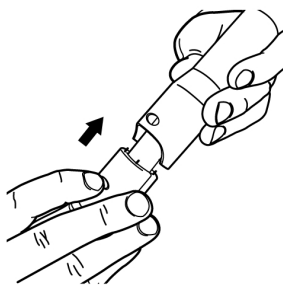

5. Place the pen cap onto the pen.

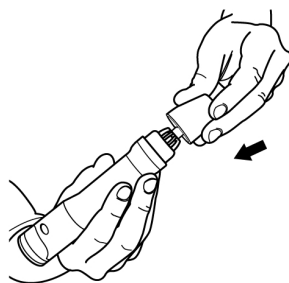

### Setting Up the MimioCapture Eraser

The MimioCapture eraser is powered by a rechargeable lithium-ion battery. The eraser charges whenever the eraser is docked on the MimioCapture tray.

#### To set up the MimioCapture eraser

- ▶ Pull the plastic strip from the top part of the eraser to activate the rechargeable battery.

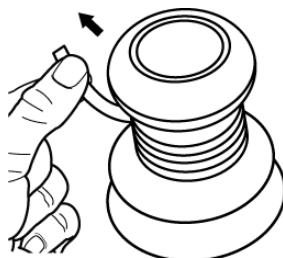

## Charging the Pens and Eraser

The MimioCapture pens and MimioCapture eraser recharge quickly whenever they are docked on the MimioCapture tray.

### To charge the pens and eraser

- ▶ Place each pen and the eraser into the appropriate part of the MimioCapture tray.

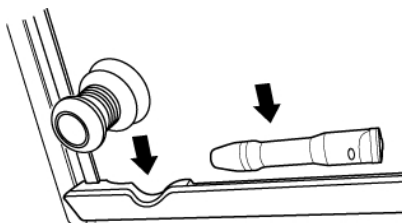

The status lights turn solid green when the pen or eraser is charging.

## Setting Up MimioStudio Notebook for Capture



To begin capturing digital ink, you must first do the following:

- Set the size of your whiteboard in MimioStudio Settings.
- Start MimioStudio Ink Capture mode.

### Setting the Whiteboard Size

Before you begin capturing digital ink, you must first set the size of your whiteboard in MimioStudio Settings. The default size is 96 inches by 48 inches.

#### To set the whiteboard size for a MimioCapture device

1. Right-click  in the notification area of the taskbar, and then choose  **Settings**. The MimioStudio Settings dialog box appears.
2. Click  **Ink Capture**.
3. If you have more than one MimioTeach bar connected to your computer, choose the device to change the size for from the **Device** list.
4. Do one of the following:
  - Choose a size from the **Surface Size** list.
  - Choose **Custom** from the **Surface Size** list and enter the desired values into the **Width** and **Height** boxes.
  - Click **Auto Size** and touch a MimioCapture pen to the whiteboard at the location shown in the **Auto Size** dialog box.

### Starting Ink Capture Mode

Using MimioStudio Ink Capture mode, you can make notes on your whiteboard and instantaneously capture them into a MimioStudio Notebook.

#### To start Ink Capture mode

- ▶ Touch the tip of any MimioCapture pen to the whiteboard.  
A new Notebook opens automatically for capturing your notes.

## Using MimioCapture

MimioCapture can be used along with MimioTeach, without a projector, to record notes and drawings from your whiteboard. This is called capturing digital ink.

### Capturing Digital Ink

When using Ink Capture mode, your notes are automatically captured in a MimioStudio Notebook. You can use the buttons on the MimioCapture tray to insert a new Notebook page, insert a copy of the current page into Notebook, or print the current Notebook page.

#### To capture digital ink

1. If your MimioTeach bar is not on, turn on your MimioTeach bar.
2. Write or draw on your whiteboard using the MimioCapture pens.
 

A new Notebook automatically opens on the connected computer and begins capturing digital ink.
3. Add, copy, and print pages as desired using the buttons on the MimioCapture tray.

### Writing and Drawing Digital Ink

In Ink Capture mode, the MimioCapture pens and the MimioCapture eraser are used to draw and erase ink on your whiteboard.

By default, the color recorded matches the color of the MimioCapture pen, regardless of the color of the marker that is inserted.

-  The MimioTeach stylus is for use with Interactive mode only. The stylus does not work with Ink Capture mode.

#### To draw digital ink

1. Choose one of the colored MimioCapture pens.
2. Draw on the whiteboard with the pen.
 

Keep the pen within 15 degrees of its perpendicular position to the whiteboard to ensure that the data is accurately captured.

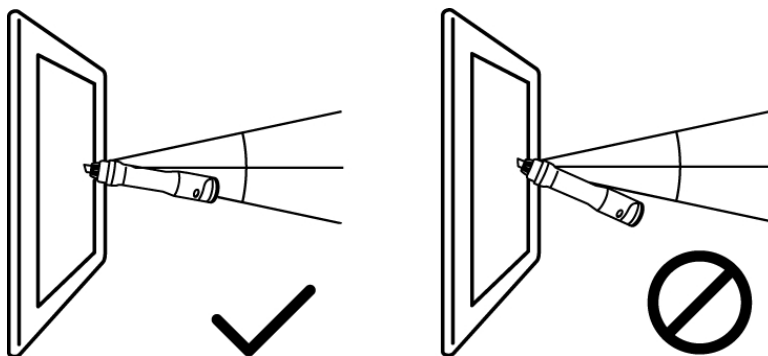

#### To erase digital ink

- ▶ Erase the ink from the whiteboard using the MimioCapture eraser.
 

Keep the eraser surface flat against the whiteboard to ensure that the data is accurately erased.



## Adding, Copying, and Printing Notebook Pages

The buttons on the MimioCapture tray can be used to easily access features directly from your whiteboard. Using the buttons on the MimioCapture tray, you can insert a new Notebook page, insert a copy of the current page into Notebook, or print the current Notebook page.

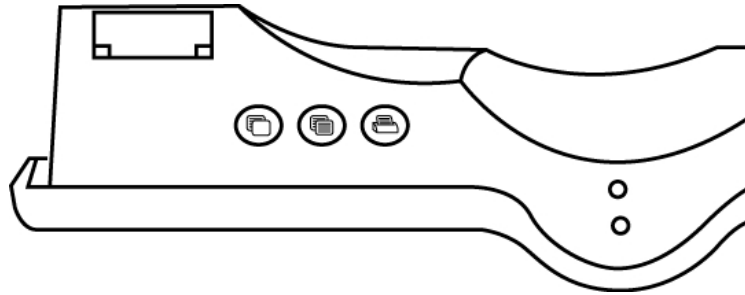
The following figure shows the MimioCapture tray buttons.



The following table describes the functions of the MimioCapture tray buttons.

	<b>New page</b>	Inserts a new page into MimioStudio Notebook.
	<b>Copy page</b>	Inserts a duplicate of the current page into MimioStudio Notebook.
	<b>Print page</b>	Prints the current page.

## Caring for MimioCapture

Review the following topics for information about cleaning, storing, and mounting your MimioCapture to a non-magnetic whiteboard.

- Cleaning MimioCapture
- Mounting MimioCapture to a Non-Magnetic Whiteboard

### Cleaning MimioCapture

MimioCapture is designed to give you long and trouble-free service, while requiring very little maintenance.

You can easily clean your MimioCapture using the following items:

- Lint-free cloth.
  - Isopropyl alcohol, diluted dishwashing detergent, or diluted glass cleaner.
-  If you use glass cleaner, make sure it does not contain ammonia.

#### To clean the MimioCapture

1. Disconnect the power cable and the connector bar.
2. Use the lint-free cloth to wipe the exterior of the MimioCapture tray, pens, and eraser.

3. Remove dirt and smudges with one of the cleaning solutions mentioned above.
  - ⚠️ Avoid using liquids on any exposed charging contacts. Do not allow liquid into any openings on the equipment.
4. Reconnect the power cable and the connector bar.

### Mounting MimioCapture to a Non-Magnetic Whiteboard

The MimioCapture tray attaches securely to any magnetic whiteboard. If you do not have a magnetic whiteboard, you can mount the MimioCapture tray to your whiteboard using the included metal plates.

#### To mount MimioCapture to a non-magnetic whiteboard

1. Place the metal plates against the back of the MimioCapture tray as shown.

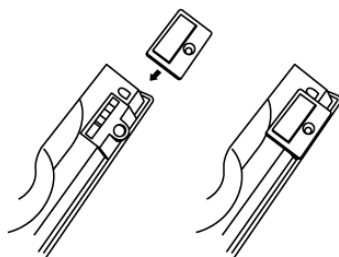

- Make sure that the recess on each plate is inserted into the recess on the back of the MimioCapture tray.

2. Remove the paper backing from the adhesive strips to expose the adhesive.

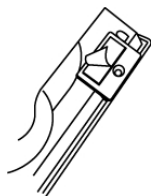

3. Press the MimioCapture tray firmly along the bottom-left edge of the whiteboard as shown.

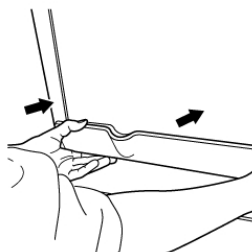

This page intentionally left blank for double-sided printing.



# Mimio Capture Kit

Mimio Capture Kit is used with a Mimio Interactive-enabled whiteboard to record notes and drawings from your whiteboard. Using MimioStudio Ink Capture mode, you make notes and drawings on your whiteboard using the Mimio Capture Kit pens. Your notes are automatically captured in a MimioStudio Notebook.

### What's Included

The Mimio Capture Kit package contains the following items:

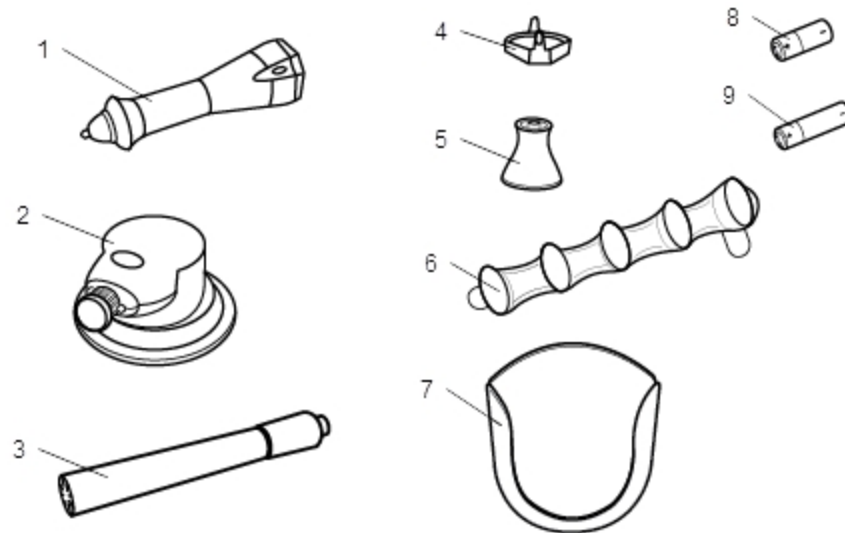

1	Mimio Capture Kit pens (4)	6	Mimio Capture Kit pen holder
2	Mimio Capture Kit eraser	7	Mimio Capture Kit eraser holder
3	Expo markers (4)	8	N-Cell batteries (4)
4	Color caps (8)	9	AAA battery
5	Mimio Capture Kit pen caps (4)		

If you are missing any of the items above, contact Customer Support.

### About Mimio Capture Kit

Mimio Capture Kit includes four pens and one eraser for making notes on your Mimio Interactive-enabled whiteboard. The pen holder and eraser holder are used to store the pens

and eraser.

The following figure shows the major components of Mimio Capture Kit.

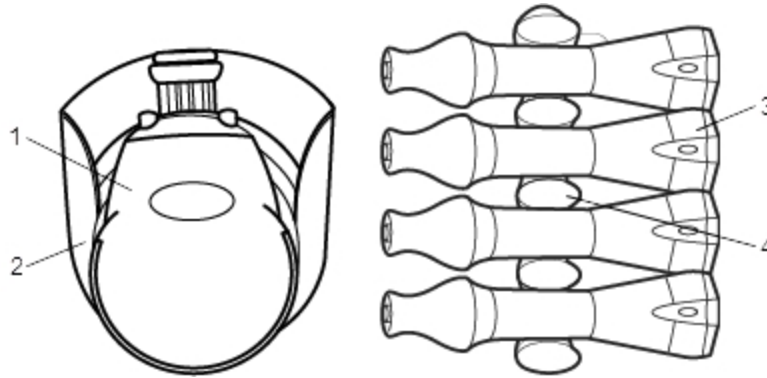

1	Mimio Capture Kit eraser	3	Mimio Capture Kit pens
2	Mimio Capture Kit eraser holder	4	Mimio Capture Kit pen holder

### About MimioStudio Notebook

As you make notes on your whiteboard using Mimio Capture Kit, you can automatically save those notes into MimioStudio Notebook. Once the information is in Notebook, you can save the Notebook as a MimioStudio INK file or a variety of other formats.

-  Your Mimio Interactive bar can capture and store ink while disconnected from your computer. See [Downloading Digital Ink](#) for more information about capturing and downloading digital ink for an offline session.

For more information about using MimioStudio Notebook, see [Working with MimioStudio Notebook](#).

### Getting Started

Mimio Capture Kit links directly to your Mimio Interactive for seamless integration with MimioStudio software. Before you can begin capturing digital ink, you must first set up your Mimio Capture Kit pens, Mimio Capture Kit eraser, and MimioStudio Notebook.

#### Setting Up the Mimio Capture Kit Pens

Mimio Capture Kit comes with four Mimio Capture Kit pens, four Expo® dry erase markers, and eight color caps. Before you can start using Mimio Capture Kit, you must first set up your Mimio Capture Kit pens.

The Mimio Capture Kit pens are each powered by one N-cell battery.

##### To set up the Mimio Capture Kit pens

- Gently turn and pull the top part of the Mimio Capture Kit pen to separate the top part of the pen from the pen body.

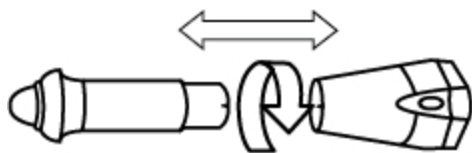

2. Press the colored nodes on each side of the pen and pull to remove the color cap.

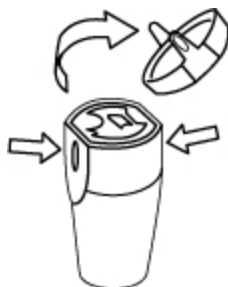

3. Insert one N-cell battery into the Mimio Capture Kit pen.



4. Replace the color cap making sure to align the spring on the color cap with the battery.



5. Insert an Expo® dry erase marker that matches the color of the color cap into the pen body.

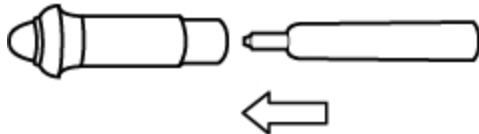

6. Align the arrow on the pen body with the arrow on the top part of the pen.

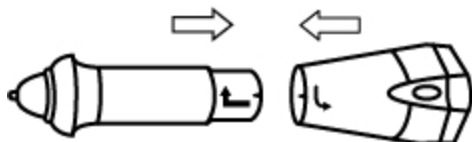

7. Push the two parts of the pen together, and then twist to lock in place.

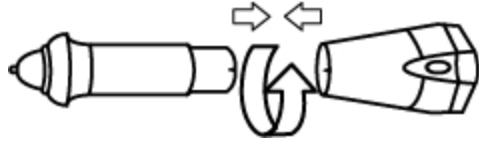

8. Place the pen cap onto the pen.



### Setting Up the Mimio Capture Kit Eraser

The Mimio Capture Kit eraser is powered by one AAA battery.

#### To set up the Mimio Capture Kit eraser

1. Lightly press both sides of the eraser and lift to remove the battery compartment cover.

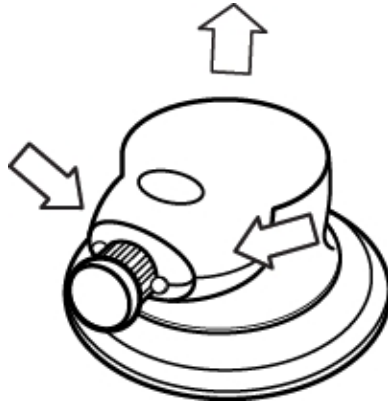

2. Insert the battery into the battery compartment.

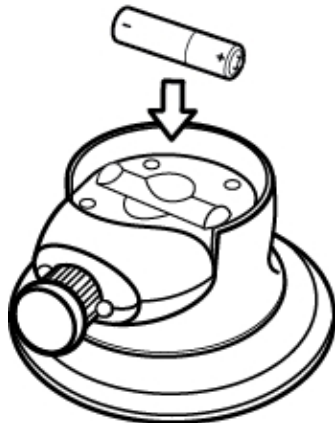

3. Replace the battery compartment cover.

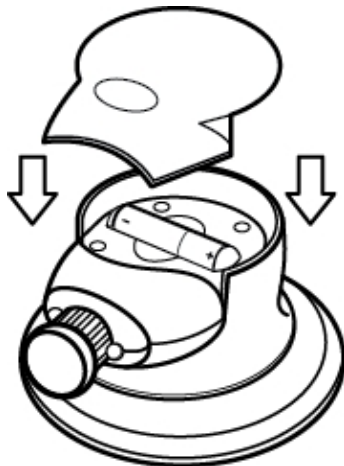

## Setting Up MimioStudio Notebook for Capture



To begin capturing digital ink, you must first do the following:

- Set the size of your whiteboard in MimioStudio Settings.
- Start MimioStudio Ink Capture mode.

### Setting the Whiteboard Size

Before you begin capturing digital ink, you must first set the size of your whiteboard in MimioStudio Settings. The default size is 96 inches by 48 inches.

#### To set the whiteboard size for a Mimio Interactive device

1. Right-click  in the notification area of the taskbar, and then choose  **Settings**.  
The MimioStudio Settings dialog box appears.
2. Click  **Ink Capture**.
3. If you have more than one Mimio Interactive bar connected to your computer, choose the device to change the size for from the **Device** list.
4. Do one of the following:
  - Choose a size from the **Surface Size** list.
  - Choose **Custom** from the **Surface Size** list and enter the desired values into the **Width** and **Height** boxes.
  - Click **Auto Size** and touch a Mimio Capture Kit pen to the whiteboard at the location shown in the **Auto Size** dialog box.

### Starting Ink Capture Mode

Using MimioStudio Ink Capture mode, you can make notes on your whiteboard and instantaneously capture them into a MimioStudio Notebook.

-  Your Mimio Interactive bar can capture and store ink while disconnected from your computer. However, you need to supply power to your Mimio Interactive bar using batteries or a wall adapter. See *Downloading Digital Ink* for more information about capturing and downloading digital ink for an offline session.

#### **To start Ink Capture mode**

- ▶ Touch the tip of any Mimio Capture Kit pen to the whiteboard.  
A new Notebook opens automatically for capturing your notes.

## **Using Mimio Capture Kit**

---

Mimio Capture Kit can be used along with Mimio Interactive, without a projector, to record notes and drawings from your whiteboard. This is called capturing digital ink.

### **Capturing Digital Ink**

When using Ink Capture mode, your notes are automatically captured in a MimioStudio Notebook. You can use the buttons on the Mimio Interactive bar to insert a new Notebook page, insert a copy of the current page into Notebook, or print the current Notebook page.

- Your Mimio Interactive bar can capture and store ink while disconnected from your computer. See [Downloading Digital Ink](#) for more information about capturing and downloading digital ink for an offline session.

#### **To capture digital ink**

1. If your Mimio Interactive bar is not on, turn on your Mimio Interactive bar.
2. Write or draw on your whiteboard using the Mimio Capture Kit pens.  
A new Notebook automatically opens on the connected computer and begins capturing digital ink.
3. Add, copy, and print pages as desired using the buttons on the Mimio Interactive bar.

### **Writing and Drawing Digital Ink**

In Ink Capture mode, the Mimio Capture Kit pens and the Mimio Capture Kit eraser are used to draw and erase ink on your whiteboard.

By default, the color recorded matches the color of the color cap on the Mimio Capture Kit pen, regardless of the color of the marker that is inserted.

- The Mimio Interactive Mouse is for use with Interactive mode only. The Mouse does not work with Ink Capture mode.

#### **To draw digital ink**

1. Choose one of the Mimio Capture Kit pens.
2. Draw on the whiteboard with the pen.

Keep the pen within 15 degrees of its perpendicular position to the whiteboard to ensure that the data is accurately captured.

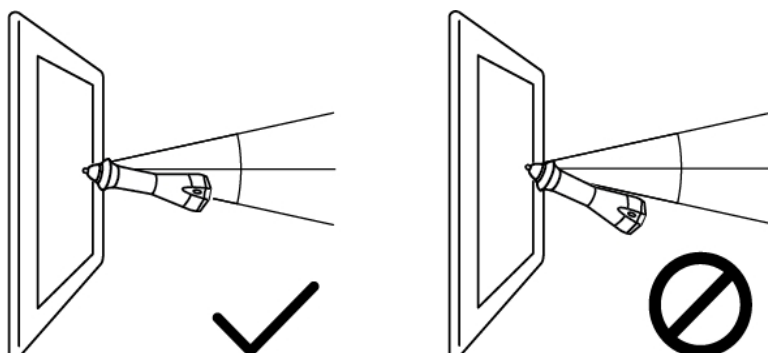

#### To erase digital ink

- ▶ Erase the ink from the whiteboard using the Mimio Capture Kit eraser. Keep the eraser surface flat against the whiteboard to ensure that the data is accurately erased.



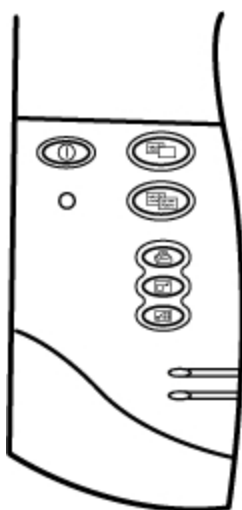

### Adding, Copying, and Printing Notebook Pages

When using Ink Capture mode, the buttons on the Mimio Interactive bar can be used to easily access features directly from your whiteboard. Using the buttons on the Mimio Interactive bar, you can insert a new Notebook page, insert a copy of the current page into Notebook, or print the current Notebook page.

The following figure shows the Mimio Interactive bar buttons.



The following table describes the functions of the Mimio Interactive bar buttons.

	<b>New page</b>	Inserts a new page into MimioStudio Notebook.
	<b>Copy page</b>	Inserts a duplicate of the current page into MimioStudio Notebook.
	<b>Print page</b>	Prints the current page.
	<b>Resize window</b>	Minimizes or Maximizes the MimioStudio Notebook window.
	<b>Interactive</b>	Exits Ink Capture mode and starts Interactive mode.

## Downloading Digital Ink

You can use your Mimio Interactive bar to record and save Digital Ink even when not connected to your computer. You can then download the Digital Ink to MimioStudio Notebook for printing, distributing, or editing.

-  When your Mimio Interactive bar is not connected to your computer through the USB cable, the Mimio Interactive bar must be powered by batteries or a power adapter.

### To download digital ink

1. Connect the Mimio Interactive bar to your computer.
2. Do one of the following:
  - If configured to automatically download digital ink (default), open a new MimioStudio Notebook.  
The ink download process begins automatically.
  - If configured to manually download digital ink, open a new MimioStudio Notebook and double-click  **Download Ink** on the status bar.

## Caring for Mimio Capture Kit

Review the following topics for information about cleaning, storing, and mounting your Mimio Capture Kit.

- Cleaning the Mimio Capture Kit
- Mounting the Mimio Capture Kit

### Cleaning the Mimio Capture Kit

Mimio Capture Kit is designed to give you long and trouble-free service, while requiring very little maintenance.

You can easily clean your Mimio Capture Kit using the following items:

- Lint-free cloth.
- Isopropyl alcohol, diluted dishwashing detergent, or diluted glass cleaner.
  -  If you use glass cleaner, make sure it does not contain ammonia.

### To clean the Mimio Capture Kit



1. Use the lint-free cloth to wipe the exterior of the Mimio Capture Kit pens, and eraser.
2. Remove dirt and smudges with one of the cleaning solutions mentioned above.  
⚠ Do not allow liquid into any openings on the equipment.

### Mounting the Mimio Capture Kit

The Mimio Capture Kit pen and eraser holders attach securely to any whiteboard.

#### To mount the Mimio Capture Kit pen holder

1. Remove the paper backing from the adhesive strips on the back of the pen holder to expose the adhesive.



2. Hold the Mimio Capture Kit pen holder vertically, and press firmly against the whiteboard as shown.

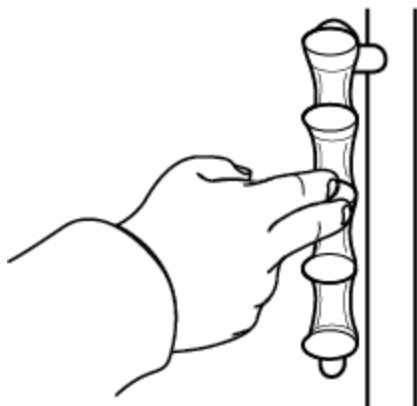

3. Insert the Mimio Capture Kit pens into the pen holder when not in use.

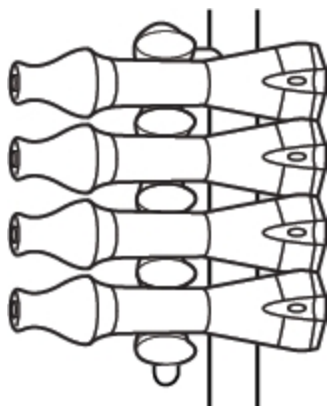

#### To mount the Mimio Capture Kit eraser holder

1. Remove the paper backing from the adhesive strips on the back of the eraser holder to expose the adhesive.



2. Press the Mimio Capture Kit eraser holder firmly against the whiteboard as shown.

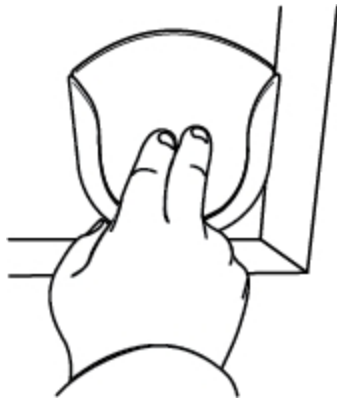

3. Insert the Mimio Capture Kit eraser into the eraser holder when not in use.

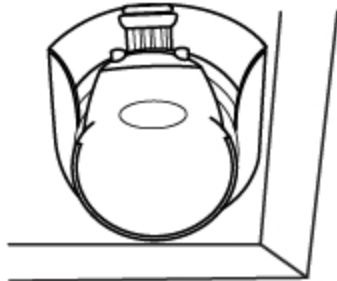

## Chapter 7

# MimioVote

MimioVote is a wireless, interactive, student response system. Using MimioVote, you can easily and quickly gather student responses. This quick feedback from students allows you to make sure each student is keeping up and adjust your lesson accordingly.

### What's Included

The MimioVote package contains the following items:

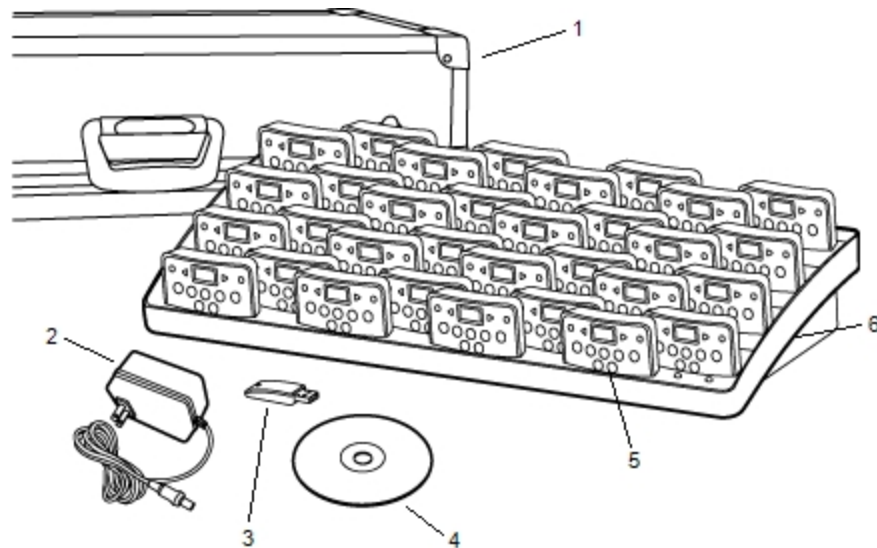

1	Carrying case	4	MimioStudio DVD
2	Power cable	5	MimioVote unit (24 or 32)
3	MimioHub	6	Charging station

If you are missing any of the items above, contact Customer Support.

### About MimioVote

Your MimioVote system comes with a charging station and either 24 or 32 MimioVote units. You can combine two MimioVote systems for a total of up to 64 units.

### About the MimioVote Station

The MimioVote station is used to recharge and store all of your MimioVote units.

You can place any MimioVote unit into any slot on the MimioVote station. The number assigned to each unit is automatically determined by the number of the slot that the unit is inserted into. There is no need to match a particular unit to a particular slot on the MimioVote station. Once a unit is inserted into the MimioVote station, the unit number appears in the unit display.

The following figure shows the major components of the MimioVote station.

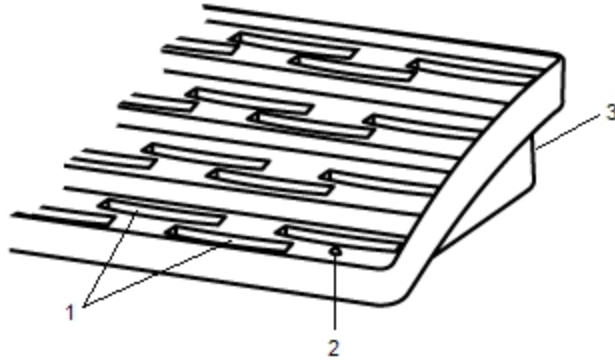

1	MimioVote unit slot
2	Status light
3	Power connector

### Status Lights

The status light visually shows the status of the MimioVote station.

Off	Not receiving power; Power cable is not connected.
Solid Green	MimioVote is connected and receiving power; MimioStudio software is running.
Flashing Green	MimioVote is connected or connecting, and receiving power; MimioStudio software is not running.
Solid Amber	MimioVote cannot find an available MimioHub.
Flashing Amber	MimioVote is searching for an available MimioHub.

### About the MimioVote Units

The MimioVote system includes either 24 or 32 MimioVote units. The MimioVote units slide into the MimioVote station to recharge or to store.

When conducting activities, the buttons on the MimioVote unit light up depending on what answers are available to the student. The available answers are determined by the teacher when the question is created. For example, if the question is a True/False question, only the ☑ and ☒ buttons are illuminated on the MimioVote unit. The A, B, C, D, and E buttons will not light up and will not register a response if pressed.

By default, each button on the MimioVote unit is illuminated with a different color light. You can choose to turn off the colors and have all the buttons illuminated with a white light. For information about changing the button colors, see *Adjusting the Vote Settings*.

The following figure shows the major components of the MimioVote unit.

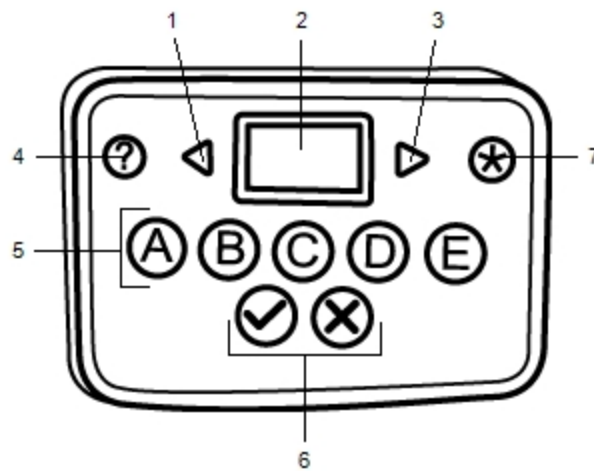

1	Previous	5	Multiple choice buttons
2	Display	5	True/False buttons
3	Next	7	Submit
4	Help		

## About the Software

MimioStudio software includes several features especially for use with your MimioVote system. MimioStudio Notebook and Gallery include everything you need to create activities to conduct with your students. The MimioStudio Vote Toolbar and MimioStudio Quick Vote include all the tools you need for conducting activities and gathering student responses. And, the MimioStudio Gradebook stores the information and results for all of your class activities.

### About MimioStudio Notebook

You can use MimioStudio Notebook to create any type of MimioVote activity. Activities are created by adding question objects to Notebook pages. The Questions and Results folder in MimioStudio Gallery includes a wide variety of pre-designed question objects to make











creating activities in Notebook quick and easy.

For more information about using MimioStudio Notebook and Gallery, see About MimioStudio.

**About the Vote Toolbar**

The Vote Toolbar includes all the tools you need for taking attendance, conducting class activities, gathering student responses, and viewing results. The Vote Toolbar is available in MimioStudio Notebook and Microsoft PowerPoint.







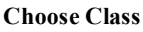

The following table describes the major features of the Vote Toolbar in MimioStudio Notebook and Microsoft PowerPoint.

 Choose Class	Select class	 00	Number responded
	Take attendance		View help requests
	Start/stop polling		Start self-paced activity
	View results		Print self-paced activity (MimioStudio Notebook only)
 00:00	Timer display		Settings (Microsoft PowerPoint only)

**About MimioStudio Quick Vote**

You can use MimioStudio Quick Vote to ask questions that are not a part of a Notebook or PowerPoint MimioVote activity. You can use Quick Vote to add a question at any time during a Teacher-Led activity.

The following table describes the major features of MimioStudio Quick Vote.

 Choose Class	Select class	 00:00	Timer display
	Take attendance	 00	Number responded
	Select question type and start/stop polling		View help requests
	View results		Settings

**About MimioStudio Gradebook**

MimioStudio Gradebook stores the results for all of your class activities. Student responses gathered using the MimioVote system are automatically saved to the Gradebook along with complete information for each question. You can also manually add activities that were not conducted using the MimioVote system, making it easy to keep all your grades in one location.

The following views are available in Gradebook, giving you easy access to the information you want to view:

- **All Classes View**

The All Classes view displays a list of all of your saved classes, the number of students in each class, and the average grade for all students in the class.

The All Classes view is displayed when no class is selected.

- **Date View**

The Date view displays a list of all students in the selected class and all dates on which any activities were conducted. Each date column shows the average grade for each student, for all activities that were conducted on that date.

From the Date view, you can also view the Class pane. The Class pane displays the name of the class, number of students in the class, and the number of activities that have been conducted with the selected class.

The Date view is displayed when a class is selected.

- **Activity View**

The Activity view displays a list of all students in the selected class. The Attendance column shows the attendance status for each student on the selected date. The activity columns show the grade that each student received for each activity conducted on the selected date.

From the Activity view, you can also view the Activity pane. The Activity pane displays the name of the activity, activity type, total number of question, and the weight of the activity.

The Activity view is displayed when a class and date are selected.

- **Activity Detail View**

The Activity Detail view displays a list of all students in the selected class. The Average column shows the grade for each student for the selected activity. Each question column shows the response that each student provided.

The Activity pane displays the name, type, and weight of the selected activity.

From the Activity Detail view, you can also view the Question pane. The Question pane displays the question text, the available and correct answers, the question snapshot, and the question weight.

The Activity Detail view is displayed when a class, date, and activity are selected.

In addition, you can view the Student pane from Date view, Activity view, or Activity Detail view. The Student pane displays the name, student ID number, MimioVote unit number, and address for the selected student.

---

## Getting Started

---

Setting up the MimioVote system is quick and easy. You can link your MimioVote system to your computer using the included MimioHub. Or, if you have MimioTeach, you can link the MimioVote system to your computer using the MimioHub that you already have installed.

## Setting Up MimioVote

Once you have installed the MimioStudio software on your computer, you can quickly set up MimioVote.

- Each MimioVote unit is powered by a rechargeable lithium-ion battery. The battery recharges whenever the unit is docked in the MimioVote station. Charging the battery for the first time will take approximately six hours; when fully discharged, recharging the battery will take approximately twelve hours.

### To set up MimioVote

1. Pull the plastic strip from each MimioVote unit to activate the rechargeable battery.

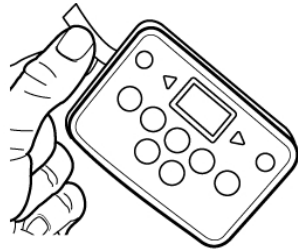

2. Insert each MimioVote unit into a slot on the MimioVote station.

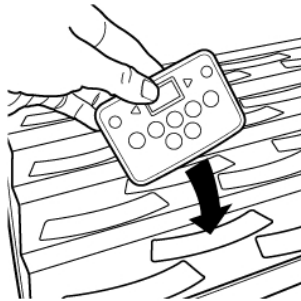

3. Plug the power cord into the power connector on the back of the MimioVote station.

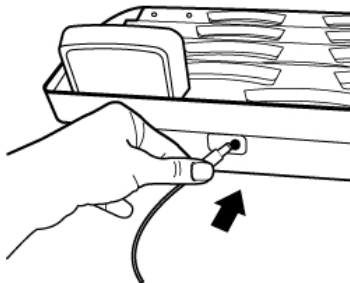

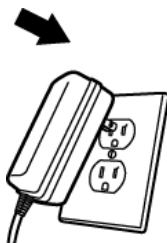

4. Plug the other end of the power cord into a power outlet.



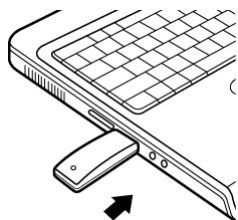

5. Plug the MimioHub into an available USB port on your computer.



-  If you already have a MimioHub installed on your computer, a dialog box appears asking if you want to connect the MimioHub to the MimioVote system. Click **Yes** to link the MimioVote system to your existing MimioHub.

## Adding a Second MimioVote System

Each MimioVote system includes either 24 or 32 MimioVote units. For larger classes, you can combine two MimioVote systems for a total of up to 64 units.

-  You can use the same MimioHub to connect all of your MimioClassroom devices to your computer.

### To add a second MimioVote system

1. Set up the MimioVote station and units as described in *Setting Up MimioVote*.  
Once the power is connected to the MimioVote system, the previously installed MimioHub will detect the new system.
2. When prompted by the software, click **Yes** to connect the new system to the MimioHub.



The second system is connected to your computer and the appropriate numbers are assigned to each MimioVote unit automatically.

-  If you do not see the prompt, or you want to connect the system at a later time, see *Adjusting the Classroom Devices Settings* for information about connecting available devices to your computer.

## Using MimioStudio Gradebook

You can use MimioStudio Gradebook to store information for all of your classes, students, and class activities. Student responses gathered using the MimioVote system are automatically saved to the Gradebook along with complete information for each question. You can also manually add activities that were not conducted using the MimioVote system, making it easy to keep all your grades in one location.

Several ways to access MimioStudio Gradebook are shown in the following table.

To start from the	Do this
Desktop	Double-click  on the desktop.
Taskbar	Right-click  , and then choose  <b>Gradebook</b> .
Start menu	Point to <b>Programs</b> , <b>MimioStudio</b> , <b>Tools</b> , and then choose <b>MimioStudio Gradebook</b> .

## Setting Up the Gradebook

Before you begin using your MimioVote system to conduct activities, you must first set up MimioStudio Gradebook. You can add as many classes as you want to Gradebook, and then add students to each of your classes.

### Creating a Class

You can create as many classes as you want in Gradebook. Once you have created a class, you can add students to the class by manually entering all student names and information, or you can import a list of students.

#### To create a class



1. Click  on the Gradebook toolbar.  
The Add Class dialog box appears.
2. Enter a name for the class in the **Name** box, and then click **Add**.  
The class is added to your class list.

### Adding Students

The number of students you can have in each class depends on the number of MimioVote units you have. You can combine two MimioVote systems for up to 64 units.

Each student that you add to a class is automatically assigned a MimioVote unit number.

#### To add a student to a class

1. Select the class to add a student to.
2. Click  on the Gradebook toolbar.  
The Add Student dialog box appears.
3. Enter the name, student ID number, and address for the student.  
 The MimioVote handset ID is assigned automatically.
4. Click **Add**.  
The student is added to the class.

### Importing a List of Students

You can add students to a class manually by entering all student names and information, or you can import an existing list of students into a class.

You can import students from a Unicode text file (TXT) or a Comma separated value file (CSV). Each student must have at least a first or last name assigned to them in order to be imported.

The following fields are supported for importing into Gradebook.

- |              |           |
|--------------|-----------|
| ■ StudentID  | ■ Address |
| ■ FirstName  | ■ City    |
| ■ MiddleName | ■ State   |
| ■ LastName   | ■ Zipcode |
| ■ Gender     | ■ Country |
| ■ Birthdate  |           |

Each student that you add to a class is automatically assigned a MimioVote unit number.

**To import a class list**

1. In Gradebook, select the class you want to import the student list into.
2. From the **File** menu, choose **Import**, and then choose **Students**.  
The Open dialog box appears.
3. Navigate to and select the file you want to import, and then click **Open**.  
The students are added to the selected class.

**Adding Activities**

You can keep track of all of your student scores using Gradebook. Scores for all MimioVote activities are automatically saved to the Gradebook. You can also manually enter activities that were not performed using MimioVote.

**To add an activity**

1. Select the class to add the activity to.
2. Click  on the Gradebook toolbar.
3. In the **Add Activity** dialog box, do the following:
  - a. Enter a name for the activity in the **Name** box.
  - b. Choose the type of activity to add from the **Type** list.
  - c. Choose the month, date, and year that the activity was performed.
  - d. Enter a weight for the activity in the **Weight** box.
  - e. Click **Add**.  
The activity is added and displayed in the Gradebook.
4. Enter a grade for each student in the **Average** column.

**Modifying the Gradebook**

You can modify the information in the MimioStudio Gradebook in the following ways:

- Edit Student Information
- Remove a Student
- Editing Activities
- Editing Questions

**Editing Student Information**

You can edit any information for an existing student, including the student name, student ID number, MimioVote unit ID number, and address.

**To edit student information**

1. Select the student to edit.
2. Click  **Edit Student** on the Student pane.  
The Edit Student dialog box appears.
3. Make any desired changes to the student information.
4. Click **OK** to save your changes.

## Removing a Student

You can delete a student from a class at any time. Deleting a student permanently removes the student from the class and removes all of their activity results from the Gradebook.

### To remove a student from a class

1. Select the class that contains the student you want to remove.
2. Select the student to remove.
3. Choose **Delete** from the **Edit** menu.
4. Follow the instructions in the **Confirm Delete** dialog box, and then click **OK**.  
The selected student and all information for the selected student is permanently deleted from the Gradebook.

## Editing Activities

You can edit the name, type, and weight for an activity at any time.

### To edit an activity

1. Select the activity to edit.
2. Click  **Edit Activity** on the Activity pane.  
The Edit Activity dialog box appears.
3. In the **Edit Activity** dialog box, you can do any of the following:
  - Enter a new name for the activity in the **Name** box.
  - Choose a different activity type from the **Type** list.
  - Enter a new weight for the activity in the **Weight** box.
4. Click **OK** to save your changes.

## Editing Questions

Each time you stop polling for a question, a copy of the question, along with the correct answer, is saved to the Gradebook. You can edit the question text, correct answer, question type, and question weight at any time in Gradebook.

For example, if the answer that was selected as the correct answer in the question object is incorrect, you can change the answer in the Gradebook to automatically update the student scores.

-  Changing the answer for a question in the Gradebook does not automatically change the answer in the question object in Notebook. To change the answer for subsequent activities, you must make the correction to the question object in Notebook.

### To edit a question

1. Select the question to edit.
2. Click  **Edit Question** on the Question pane.
3. In the **Edit Question** dialog box, you can do any of the following:
  - Edit the question or answer text under **Question Information**.
  - Click the button to the left of the correct answer to change the correct answer for the question.

- Choose a different question type from the **Type** list.
  - Enter a new weight for the question in the **Weight** box.
4. Click **OK** to save your changes.

## Generating Reports

You can generate a variety of reports from MimioStudio Gradebook. Reports are generated as HTML files and are displayed in your default Web browser.

You can generate the following types of reports:

- Class Grade Report- a grade report for all students in the selected class
- Class Activity Report - a detailed report for the selected activity
- Student Summary Report- a summary report of all activities for the selected student
- Student Activity Report - a detailed report for all selected activities for the selected student

You can generate reports from the Class, Activity, and Student panes in Gradebook or from the Report menu.

## Exporting a List of Students

You can export a list of students from any class you have saved in Gradebook to a Unicode tab-delimited text file (TXT).

### To export a list of students

1. Display the class that contains the students you want to export.
2. From the **File** menu, choose **Export**, and then choose **Students**.  
The Export Students dialog box appears.
3. Select **Export student information**, and then click **OK**.  
The Save As dialog box appears.

## Archiving Classes

You can archive your classes by exporting a class to a MimioStudio Gradebook Archive (MVA) file. The archive file contains all student, activity, and results information. You can use this file to backup your classes or to move classes from one Gradebook to another.

### To archive a class

1. From the **File** menu, choose **Export**, and then choose **Class**.  
The Export Class dialog box appears.
2. Select **Export class information**, and then click **OK**.  
The Save As dialog box appears.

## Exporting Results

You can export class and activity results from the Gradebook to a Unicode tab-delimited text file (TXT) for use in another application. You can export the following information:

- Class results - includes the class average for each student in the selected class.
- Class and activity results - includes the class average for each student as well as the grade each student received for each activity
- Activity results - includes the grade for each student for the selected activity.

**To export class results**

1. From the **File** menu, choose **Export**, and then choose **Class**.  
The Export Class dialog box appears.
2. Select **Export class results**, and then click **OK**.  
The Save As dialog box appears.
3. Enter a name for the file in the **File name** box, and then click **Save**.

**To export class and activity results**

1. From the **File** menu, choose **Export**, and then choose **Class**.  
The Export Class dialog box appears.
2. Select **Export class and activity results**, and then click **OK**.  
The Save As dialog box appears.
3. Enter a name for the file in the **File name** box, and then click **Save**.

**To export activity results**

1. From the **File** menu, choose **Export**, and then choose **Activity**.  
The Export Activity dialog box appears.
2. Select **Export activity results**, and then click **OK**.  
The Save As dialog box appears.
3. Enter a name for the file in the **File name** box, and then click **Save**.

## Opening Archived Classes

You can open your archived class files at any time by importing the archive (MVD) file into the Gradebook. Once imported, all classes in the archive file will appear along with your current classes in the Gradebook.

**To open archived classes**

1. Choose **Import Classes** from the **File** menu.  
The **Open** dialog box appears.
2. Navigate to and select the archive file to import, and then click **Open**.

## Creating MimioVote Activities

---

You can create MimioVote activities in MimioStudio Notebook or Microsoft PowerPoint.



You can also use MimioStudio Quick Vote to ask questions that you did not previously create in Notebook or PowerPoint.

You can add the following types of questions to your activity:

- TF - True/False, Yes/No, or Agree/Disagree
- AB - Multiple choice, two possible answers
- ABC - Multiple choice, three possible answers

- ABCD - Multiple choice, four possible answers
- ABCDE - Multiple choice, five possible answers



### Creating Activities in Notebook

You can use MimioStudio Notebook to create any type of MimioVote activity. Activities are created by adding question objects to Notebook pages. The Questions and Results folder in MimioStudio Gallery includes a wide variety of pre-designed question objects to make creating activities in Notebook quick and easy.

-  Each question object contains a single question, and each question must be on a separate Notebook page.

Once you've added a question object to an activity, you can customize the object properties to change the appearance or behavior of the question object.

#### To create an activity in Notebook

1. Open a new or existing Notebook.
  2. In MimioStudio Gallery, click the plus sign next to the **Questions and Results** folder, and then select the **Questions** folder.
  3. Drag the desired question object from the Gallery into the Notebook.
    -  Only one question object can be placed on each Notebook page.
  4. Enter the question text in the Question box.
  5. Enter an answer choice for the question in each of the Answer boxes.
  6. Select the correct answer.
  7. To add another question to the activity, do the following:
    - a. Click  to add a new page to the Notebook.
    - b. Repeat steps 3-6 to add a question to the new page.
- Creating an Activity in PowerPoint

### Creating Activities in PowerPoint®

You can use the MimioStudio Vote Add-in to create any type of MimioVote activity in Microsoft® PowerPoint®. MimioVote activities are created by adding question slides to a PowerPoint® presentation. The MimioStudio Vote Add-in includes a variety of pre-formatted question slide templates to make creating activities in PowerPoint® quick and easy.

#### To create an activity in PowerPoint®

1. Open a new PowerPoint® presentation.
2. Click **Insert Slide** on the Add-Ins toolbar, and then choose the type of question slide you want to add.
 

The slide is added to the presentation.
3. Enter the question text in the Question box.
4. Enter an answer choice for the question in each of the Answer boxes.
5. Click **Set Correct Answer** on the Add-Ins toolbar.
 



The Set Correct Answer dialog box appears.
6. Select the correct answer for the question.

7. Enter a weight for the question in the **Question Weight** box, and then click **OK**.
8. Repeat steps 2-7 to add all additional questions to the activity.

## Modifying Question Objects

MimioStudio Gallery includes a variety of pre-designed question objects for creating MimioVote activities. Once you add a question object to a Notebook page, you can use the question objects as is or you can choose to change the properties of the question object. You can change the question type, animation for correct answers, and question weight.

### To modify a question object

1. Click  at the bottom-right of the question object you want to modify.  
The question object properties appear.
2. In the question object properties, you can do any of the following:
  - To change the question type, select an available question type.
  - To change the correct answer animation, select an available animation.
  - To change the weight of the question, enter the weight for the question in the weight, , box.
3. Click  to save your changes and display the question object.

Creating an Activity in PowerPoint

## Importing Standard Assessments

You can import standard assessments into MimioStudio Notebook for use with MimioVote. Only files that have been exported from ExamView® as Blackboard® (6.0-7.0) format can be imported into Notebook.

-  For information about installing ExamView®, and downloading and exporting ExamView® files, see the ExamView® documentation.

### To import a standard assessment

1. Start MimioStudio Notebook, and then click .  
The Open dialog box appears.
2. Navigate to and select the file to import, and then click **Open**.  
The file is imported and displayed in Notebook.

Creating an Activity in PowerPoint

## Printing Activities

You can print an activity from Notebook to use as a self-paced activity. Normally, when you print a Notebook presentation, each page of the Notebook prints on a separate page. However, you can choose to print the activity so that multiple questions appear on a single page.

-  When you choose to print an activity, an HTML file is created from the Notebook activity. The HTML file contains all question and answer text, but no images. You can choose to print or save the HTML file.

### To print an activity



1. Open the activity to print.
2. Click  on the Vote Toolbar.  
The Select Class dialog box appears.
3. Select the class to print the activity for from the **Class** list, and then click **OK**.  
The activity is displayed as an HTML file in your default Web browser.
4. Choose **Print** from the **File** menu.  
The Print dialog box appears.
5. Click **Print**.  
Creating an Activity in PowerPoint

## Using the MimioVote Unit



---

Each MimioVote unit is assigned to one student per class. Students should use their assigned MimioVote unit each time an activity is conducted.

By default, each button on the MimioVote unit is illuminated with a different color light. You can choose to turn off the colors and have all the buttons illuminated with a white light. For information about changing the button colors, see Adjusting the Vote Settings.

### Answering Questions

Depending on the type of question being asked, the appropriate buttons are illuminated on the MimioVote unit.

For example, when polling is started for a True/False question, only the  and  buttons are illuminated on each MimioVote unit. The A, B, C, D, and E buttons are not illuminated and will not register a response if pressed.

#### Answering Questions for Teacher-Led Activities

For teacher-led activities, questions are answered one at a time as they are displayed.

##### To answer a question







- ▶ Press the button on the MimioVote unit that corresponds to the correct answer for the displayed question.

#### Answering Questions for Self-Paced Activities

For self-paced activities, questions can be answered in any order. The current question number is displayed on the MimioVote unit. For each question, the available answer buttons are illuminated, as well as the next and previous buttons.

##### To answer questions in a Self-Paced activity

1. Press the button on the MimioVote unit that corresponds to the correct answer for the first question.  
The unit automatically advances to the next question. The current question number appears in the unit display.

2. Repeat step 1 for each remaining question in the activity.
    -  You can change your answer to any question at anytime before submitting your answers. Use  and  to move through the questions and review or change any answers as desired. The currently selected answer button flashes.
  3. When all questions in the activity have been answered, press .
-  You must answer every question before submitting the activity. The  button will not become available until all questions have been answered.

## Requesting Help

A student can request help or request to ask a question at anytime using the MimioVote unit.

### To request help

- ▶ Press  on the MimioVote unit.

For information about viewing help requests, see [Viewing Requests for Help](#).

## Using the Vote Toolbar



---

The Vote Toolbar includes all the tools you need for taking attendance, conducting class activities, gathering student responses, and viewing results.

## Taking Attendance

You can quickly take attendance and record the results using MimioVote.

### To take attendance

1. Select the class to take attendance for from the Class list.
2. Click  on the Vote Toolbar.
  - A list of all students in the selected class is displayed in the Attendance window.
  - As each student indicates that they are present, the icon for that student is illuminated.
  - A student indicates they are present by pressing  on their MimioVote unit.
3. Close the **Attendance** window to stop taking attendance and save the results to the Gradebook.

## Using the Timer

The timer on the Vote Toolbar displays the amount of time that has passed since you started polling.

-  The timer automatically starts each time you start polling and automatically stops each time you stop polling.

## Conducting Activities

Using MimioVote, you can perform teacher-led or self-paced activities. Review the following topics for information about conducting activities.

- [Conducting a Teacher-Led Activity](#)
- [Asking Questions Using Quick Vote](#)
- [Conducting a Self-Paced Activity](#)

- Viewing Question Results
- Viewing Session Results
- Viewing a List of Students that Have Not Responded



### Conducting a Teacher-Led Activity

Once you have created an activity in Notebook or PowerPoint®, you can perform the activity with your class. When performing a Teacher-Led activity, the questions are displayed one at a time for the students.

 You can ask questions that you did not previously create in Notebook or PowerPoint at any time during a Teacher-Led activity using MimioStudio Quick Vote.

#### To conduct a teacher-led activity

1. Open the Notebook or PowerPoint presentation that contains the activity you want to conduct.
2. Select the class that will participate in the activity from the Class list.
3. *(Required for PowerPoint only.)* Set the display to Full Screen or Slide Show view.
4. Display the first question for the class.
5. Click  on the Vote Toolbar to start polling for the question.

 In Notebook, you can also start and stop polling directly from the question object by clicking .







When all students have responded, polling for the question stops and the results are saved to the Gradebook.

6. To stop polling for a question before all students have responded, click . Polling stops and the results are saved to the Gradebook.
7. Repeat steps 4-6 for each remaining question in the activity.
8. When all questions in the activity have been answered, close the presentation and the Vote Toolbar to stop the activity.

### Asking Questions Using Quick Vote

Using the MimioStudio Quick Vote, you can ask questions that you did not previously create in Notebook or PowerPoint at any time during a Teacher-Led activity.









#### To ask a question using Quick Vote

1. Do one of the following to start Quick Vote:
  - Right-click , and then choose  **Quick Vote**.
  - *(Interactive mode Only)* Press the **Launch** button, , on the MimioTeach bar, and then click  **Quick Vote**.
2. Select the class that will participate in the activity from the Class list.
3. Click , and then choose the question type to start polling for the question. When all students have responded, polling for the question stops.
4. To stop polling for a question before all students have responded, click .
5. Click the letter that corresponds to the correct answer for the question. The results for the current question are saved to the Gradebook along with a screen shot.

## Conducting a Self-Paced Activity

Once you have created an activity in Notebook or PowerPoint®, you can perform the activity with your class. When performing a Self-Paced activity, each student must have a printed copy of all questions in the activity. For information about printing activities, see Printing Activities.





### To conduct a self-paced activity

1. Open the Notebook or PowerPoint presentation that contains the activity you want to conduct.
2. Select the class that will participate in the activity from the Class list.
3. *(Required for PowerPoint only.)* Set the display to Full Screen view.
4. Click .  
The Self-Paced Test window appears.
5. (Optional) Use the  and  buttons to set the timer.  
The timer displays the amount of time left for the activity.  
 If you do not set the timer, the timer displays the amount of time that has passed since polling started.
6. Click  to start polling for all questions.  
Each student can move through the questions at their own pace using the  and  buttons on their MimioVote unit.  
When all students have submitted their responses or when the timer runs out, polling for the activity stops and the results are saved to the Gradebook.
7. To stop polling for an activity before all students have submitted their response or before the timer runs out, click .  
All results for the activity are saved to the Gradebook.

## Viewing Question Results

You can instantly view the results for a question as soon as you stop polling. There are a variety of ways to view the results for a question.



### To view the result for a question

1. Click , and then choose **Question Results**.  
The Question Results window appears.
2. To modify the appearance of the results, click .  
 You can change the type and colors of the graph shown. You can also choose to show the number or percentage of correct answers.
3. Click  to save your changes and view the results.

## Viewing Activity Results

You can instantly view the results for an activity as soon as you stop polling. There are a variety of ways to view the results for an activity.

### To view the result for an activity

1. Click , and then choose **Activity Results**.  
The Activity Results window appears.
2. To modify the appearance of the results, click .
3. Click  to save your changes and view the results.

### Viewing a List of Students that Have Not Responded

While you are polling a class, the number of students that have responded to the current question is displayed on the Vote Toolbar. You can quickly view a list of all students that have not yet responded.

#### To view a list of students that have not responded

- ▶ Click  on the Vote Toolbar.  
A list of students that have not yet responded is displayed in a separate window.

### Viewing Requests for Help

Using their MimioVote unit, a student can request help or request to ask a question at anytime. For information on using the MimioVote unit to request help, see Requesting Help.

You can quickly view a list of all students that have requested help.

#### To view students requesting help

1. Click  on the Vote Toolbar.  
A list of students that have requested help is displayed in a separate window.
2. Click the icon for a student to remove that student from the list.

## Caring For MimioVote

---

Review the following topics for information about cleaning and storing your MimioVote system.

- Cleaning MimioVote
- Storing MimioVote

### Cleaning MimioVote

The MimioVote is designed to give you long and trouble-free service, while requiring very little maintenance.

You can easily clean your MimioVote using the following items:

- Lint-free cloth.
- Isopropyl alcohol, diluted dishwashing detergent, or diluted glass cleaner.  
 If you use glass cleaner, make sure it does not contain ammonia.

#### To clean the MimioVote station and units

1. Disconnect the power cable.
2. Use the lint-free cloth to wipe the exterior of the MimioVote station and each MimioVote unit.

3. Remove dirt and smudges with one of the cleaning solutions mentioned above.
  -  Avoid using liquids on any exposed charging contacts. Do not allow liquid into any openings on the equipment.
4. Reconnect the Power cable.

### **Storing MimioVote**

The MimioVote system comes with a carrying case for your MimioVote station and MimioVote units. You can use this case to transport the system and to safely store your MimioVote system when not in use.

## Chapter 8

# MimioView

MimioView works seamlessly with MimioStudio software to display documents, three-dimensional objects, and microscope slides for your entire class to view. You can use MimioView to display still images or live video.

### What's Included

The MimioView package contains the following items:

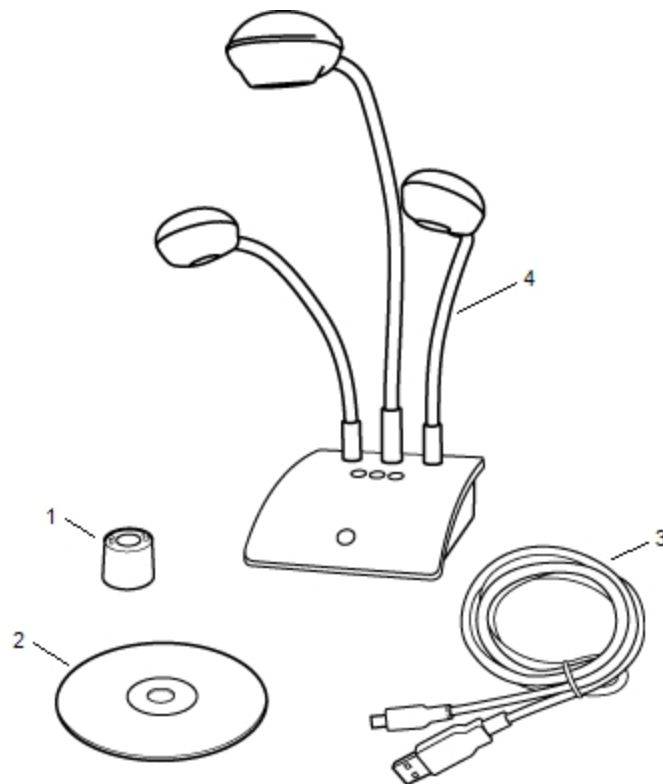

1	Microscope adapter	3	USB cable
2	MimioStudio DVD	4	MimioView document camera

If you are missing any of the items above, contact Customer Support.

## About MimioView

You can use the MimioView camera to display documents, three-dimensional objects, and microscope slides.

The MimioView camera and lamps are each attached to the MimioView base by a flexible, gooseneck. This allows you to precisely position the camera and each lamp for the best possible view of the object you are displaying.

The following figure shows the major components of the MimioView camera.

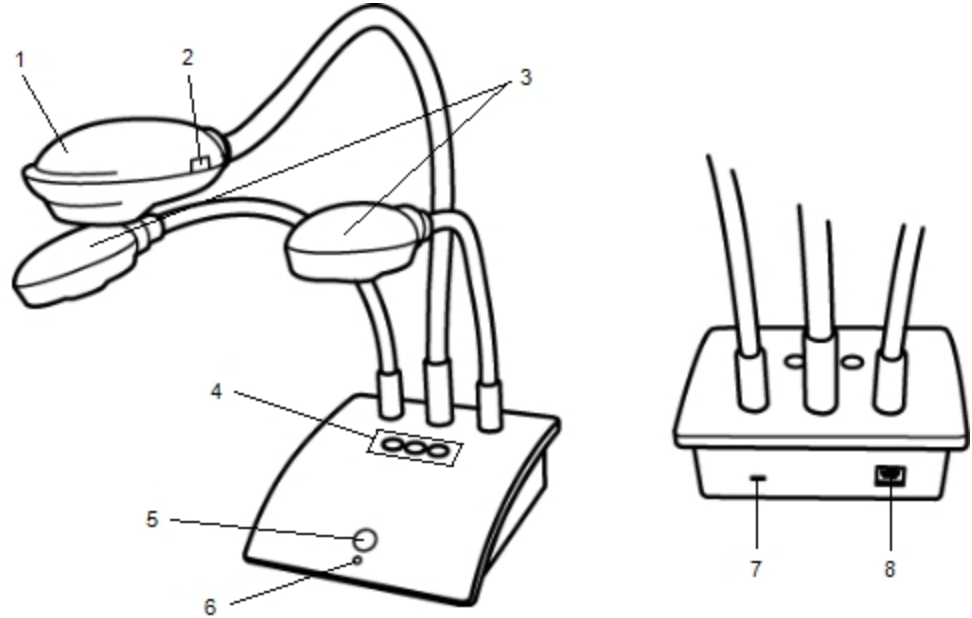

1	Camera head	5	View button
2	Auto focus	6	Status light
3	LED lamps	7	Kennsington lock slot
4	Auto tune, Rotate, and Freeze buttons	8	Micro-B USB port

## Status Lights

The status light visually shows the status of the MimioView camera.















Off	Not receiving power; USB cable is not connected or computer is turned off.
Solid Green	MimioView is connected and receiving power; MimioStudio software is running.
Flashing Green	MimioView is connected and receiving power; MimioStudio software is not running.



## About MimioStudio View

The View window displays the image captured by the MimioView camera. From the View window, you can rotate or zoom the image, mark up the image using MimioStudio Tools, adjust the contrast and brightness settings, freeze the image, and so on.

The following table describes the major features of the MimioStudio View window.

	Lamps on/off		Copy image
	Auto tune		Zoom in
	Adjust brightness, contrast, and focus		Zoom out
	Rotate counter-clockwise 90 degrees		Zoom to fit window
	Rotate clockwise 90 degrees		Open MimioStudio Tools
	Freeze image		Record live image
	Clear all markups		View full screen

## Getting Started

Review the following topics to install and start using MimioView.

- Installing MimioView
- Opening the View Window
- Closing the View Window

### Installing MimioView

Once you have installed the MimioStudio software on your computer, you can quickly install MimioView.

#### To install MimioView

1. Remove the protective covering from the MimioView camera lens.

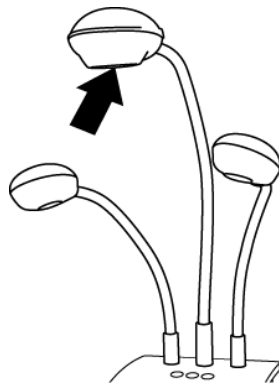

2. Plug the USB cable into the Micro-B USB port on the back of the camera base.

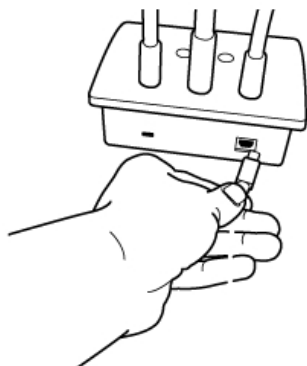

3. Connect the other end of the USB cable into an available USB port on your computer.

### Opening the View Window

When you press the View button on the MimioView, the camera and lamps turn on and the MimioStudio View window opens automatically.

#### To open the View window

- ▶ Press  on the MimioView base.  
The MimioStudio View window opens and the camera and lamps turn on.

### Closing the View Window

You can close the MimioStudio View window from the View window or directly from the MimioView camera.

#### To close the View window

- ▶ Do one of the following:
  - Close the MimioStudio View window.  
The camera and lamps turn off automatically.
  - Press  on the camera base.  
The camera and lamps turn off and the MimioStudio View window closes.

## Using MimioView

---

You can use MimioView to display a still image or live video of documents, three-dimensional objects, or microscope slides. You can also use MimioStudio Tools to mark up the still image or live video displayed in the View window; you can then save the image to a Notebook or the Gallery for later use.

### Displaying an Image

You can use MimioView to display a still image or live video of documents, three-dimensional objects, or microscope slides.

#### Displaying a Document

You can use MimioView to display a document, book, or other two-dimensional object.



##### To display a document

1. Place the document under the MimioView camera.
2. Adjust the camera head so that the desired image is displayed in the View window.
3. Adjust the lamps to light the document as desired.
4. Press  on the MimioView base.

### Displaying an Object

Using MimioView, you can display a three-dimensional object. The camera and lamps are each attached to the MimioView base by a flexible, gooseneck. This allows you to precisely position the camera and lamps for the best possible view of the object you are displaying.

#### To display a three-dimensional object

1. Place the object under the MimioView camera.
2. Adjust the camera head so that the desired image is displayed in the View window.
3. (Optional) Press  to rotate the image to the desired orientation.
4. Adjust the lamps to light the object as desired.
5. Press  on the MimioView base.

### Displaying a Microscope Slide

Using the included microscope adapter, you can display an image from a microscope with the MimioView camera.

 The microscope adapter can be used with a 28 mm microscope eyepiece.

#### To display a microscope slide

1. Set up the microscope so that you have the desired view through the microscope eyepiece.
2. Twist and lock the microscope adapter onto the MimioView camera head.
3. Slowly and carefully slide the other end of the microscope adapter onto the microscope eyepiece.

 Use caution to make sure that the image stays in focus while attaching the microscope adapter.

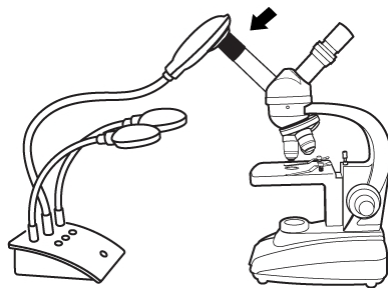

The image from the microscope is displayed in the View window.



4. Make any adjustments necessary to the microscope to adjust the image.
5. Press  on the MimioView base.

### Freezing the Image

The image captured by the MimioView camera is displayed in the View window. By default, a live image is displayed. However, you can choose to display a still image of the

object.

#### To freeze the image

- ▶ Do one of the following:
    - Press  on the MimioView base.
    - Click  on the View toolbar.
- The image is paused in the View window.

 To return to displaying live video, press  or click  a second time.

## Adjusting the Image

MimioView includes features that make it easy to adjust the image displayed in the MimioStudio View window without having to adjust the camera or the displayed object.

You can do the following to adjust the displayed image:

- Rotate the Image
- Zoom the Image
- Adjust the Settings

### Rotating the Image



You can quickly rotate the image that is displayed in the View window directly from the MimioView camera or from the View window.

#### To rotate an image from the MimioView camera

- ▶ Press  on the MimioView.

The image displayed in the View window rotates clockwise 90 degrees.

#### To rotate an image from the View window



- ▶ Do one of the following:
    - To rotate the image clockwise, click .
    - To rotate the image counter-clockwise, click .
- The image displayed in the View window rotates 90 degrees in the selected direction.

### Zooming the Image

You can quickly zoom the image displayed in the View window.

 You can also zoom the image displayed in the View window using the Zoom tool in MimioStudio Tools.

#### To zoom the image



- ▶ Do one of the following:
  - To zoom in on the image, click  on the toolbar.
  - To zoom out on the image, click  on the toolbar.
  - To fit the image to the MimioStudio View window, click  on the toolbar.

 If the area of the image that you want to display is not visible in the View window, use the scroll bars to display the desired area of the image.



## Adjusting the Settings

You can adjust the brightness and contrast settings automatically or manually.

### To adjust the settings automatically

- Do one of the following:
  - Press  on the MimioView base.
  - Click  on the View toolbar.

### To adjust the settings manually

1. Click  on the View toolbar.  
The Advanced Settings toolbar appears.
2. Move the Brightness and Contrast sliders to the right or left to adjust the settings as desired.
3. Click  to hide the Advanced Settings toolbar.



## Annotating an Image

You can use MimioStudio Tools to annotate the image displayed in the View window.

 You can also add objects to the View window from MimioStudio Gallery.

See Adding Objects with MimioStudio Tools for information about using MimioStudio Tools.

The following object, drawing, and manipulation features in MimioStudio Tools are available to use in the View window.

	Selection tool		Zoom
	Pen		Brush
	Text		Highlighter
	Line		Arrow End
	Arrow Start		Arrow Both
	Rectangle		Ellipse
	Triangle		Right Triangle
	Five Pointed Star		Hexagon
	Pentagon		Shape Recognition
	Eraser		Insert file
	Color picker		More colors
	Object Fill		Thickness slider
	Outline and Fill color		Color palette
	Solid Line		Dash Line
	Dotted Line		Transparency

### Clearing All Annotations from the Image

You can quickly clear all annotations from the View window.

#### To clear all annotations

- ▶ Click  on the View toolbar.  
All annotations, including any added objects, are cleared from the View window.

### Transferring an Image

You can transfer all or part of an image from the View window to a Notebook page, the Gallery, or another application.

#### To transfer an image

1. Click  on the View toolbar.  
The Image area is displayed with a transparent mask.
2. Drag the cursor to draw a selection box around the area to copy.

- The selected area is saved as an image to the clipboard.
3. Paste the image into the desired application.



## Recording Video

Using MimioStudio Recorder, you can record your interactions into an AVI movie file, with or without audio. See Using MimioStudio Recorder for more information on how to use MimioStudio Recorder.

## Turning Off the Lamps

When you turn on MimioView, the camera and both lamps turn on. However, you can choose to turn off the lamps and use the camera without the lamps.

### To turn off the lamps

- Click  on the View toolbar.
-  To turn the lamps on again, click  a second time.

## Caring For MimioView

---

Review the following topics for information about cleaning, storing, and mounting your MimioView.

- Cleaning MimioView
- Mounting MimioView Permanently

## Cleaning MimioView

The MimioView is designed to give you long and trouble-free service, while requiring very little maintenance.

You can easily clean your MimioView using the following items:

- Lint-free cloth.
- Isopropyl alcohol, diluted dishwashing detergent, or diluted glass cleaner.
-  If you use glass cleaner, make sure it does not contain ammonia.

### To clean the exterior of the MimioView

1. Disconnect the USB cable.
2. Use the lint-free cloth to wipe the exterior of the MimioView.
3. Remove dirt and smudges with one of the cleaning solutions mentioned above.
  -  Do not allow liquid into any openings on the equipment.
4. Reconnect the USB cable.

### To clean the camera lens

- ▶ Use a clean, dry, lint-free cloth to gently wipe the surface of the lens.

## Mounting MimioView Permanently

You can permanently mount your MimioView to a table or desk top using a standard VESA mount and four screws (size M4).

### To mount MimioView permanently

1. Attach the VESA mount to the table or desktop.  
For information about attaching the VESA mount to your table or desktop, see the VESA documentation.
2. Attach the VESA base to the bottom of the MimioView as shown.

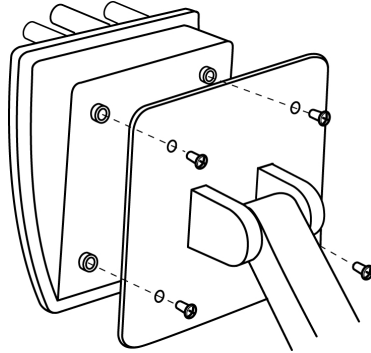



## Chapter 9

# Mimio Pad

Mimio Pad is a 2.4 GHz wireless pad. To configure Mimio Pad for use, install the MimioStudio software and plug the wireless receiver into your computer. Once connected, you can use the Mimio Pad from anywhere in the room to interact with your computer. No additional configuration is required.

### What's Included

The Mimio Pad package contains the following items:

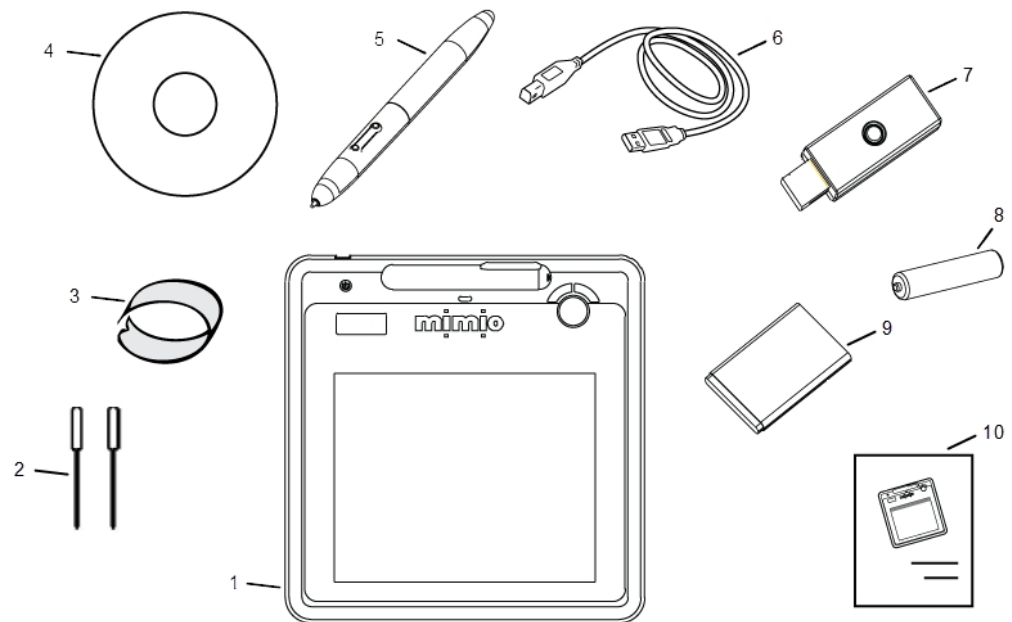

1	Mimio Pad	6	USB cable
2	Extra pen tips (inside Mimio Pad battery compartment)	7	Wireless receiver
3	Pen tip extractor (inside Mimio Pad battery compartment)	8	Pen battery
4	MimioStudio DVD	9	Pad battery
5	Pen	10	Quick Start Guide

If you are missing any of the items above, contact Customer Support.

### About Mimio Pad

Become familiar with the features of your Mimio Pad as shown in the following illustrations.

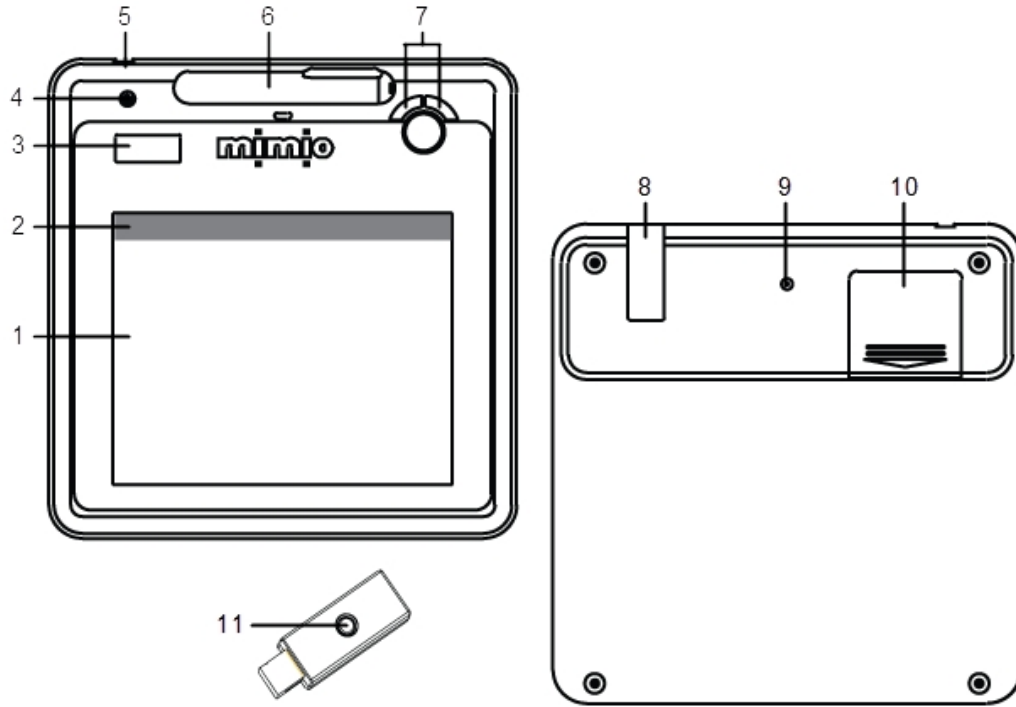







1	Active area	7	Page up/Page down Volume up/Volume down
2	Shortcut keys	8	Wireless receiver storage
3	LCD display	9	Learning button
4	Power button	10	Battery compartment (extra pen tips and pen tip extractor)
5	USB connection	11	Learning button/LED
6	Pen slot		

### About the Feature Indicators

The feature indicators on the LCD display are described below.



	Power	The power is on.
	Battery Indicator	Shows how much charge is left in the Mimio Pad battery.
	Power Saving Mode	Power saving mode is on. The Mimio Pad enters power saving mode when the pen is away from the active area for three seconds.
	Connected	The Mimio Pad is connected to your computer.
	Wireless Activity	The wireless receiver is active.
	Pen Sensor	Blinking: Pen tip is in range of active area; indicates hover mode. Solid: Pen tip is touching active area; indicates left-click.
	Pad Number	When more than one Mimio Pad is connected to a receiver, shows the number of the connected Mimio Pad.

## Getting Started

### Setting Up the Mimio Pad

Your Mimio Pad is installed at the same time you install the MimioStudio software. Follow these instructions to begin using your Mimio Pad.

#### To insert the battery

1. Press down and slide off battery compartment cover.
2. Insert the battery.

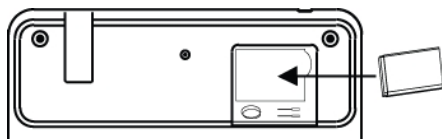

3. Replace the battery compartment cover.

### Charging the Battery

The Mimio Pad battery is charged using the included USB cable. The Li-ion Mimio Pad battery may contain some charge right out of the box. However, for best results, completely charge the battery before using the Mimio Pad. The first time you charge the battery may take up to 10 hours. After the initial charge, recharging of the battery will take approximately two hours.

#### To charge the battery

1. Plug the USB cable into the pad and into your computer.
2. When the battery is fully charged, unplug the USB cable from the pad and your computer.

### Setting Up the Pen

The pen uses one AAA battery.

### To insert the pen battery

1. Twist the top of the pen counterclockwise.



2. Lift the battery cover, and insert battery as shown.

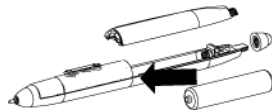

3. Replace battery cover and pen top.



## Configuring Mimio Pad

Delete this text and replace it with your own content.

### To configure Mimio Pad

1. Plug the wireless receiver into a USB port on your computer.
2. Press and hold the power button on the pad for at least three seconds to turn on the power.
3. Place the pen tip anywhere on the active area of the pad to wake up the pad.
4. Verify that the LCD display shows at least the following indicators.



















Your Mimio Pad is now ready to use.

## Using Mimio Pad

---

### Using the Shortcut Keys

Shortcut keys are available across the top of the active area of the pad. These keys allow you to quickly access features in the MimioStudio software.

	Selection Tool		Screen Clipping
	Pen		Screen Annotation
	Highlighter		Text Tool
	Eraser		Spotlight Tool
	Cut		Reveal Tool
	Copy		Notebook
	Paste		Tools
	New Page		Recorder

## Changing the Pen Tip

After a period of use, you may need to replace the pen tip. Extra pen tips and a pen tip extractor are located inside the pad battery compartment.

### To change the pen tip

1. Squeeze the pen tip with the tip extractor, and then pull out to remove the tip.

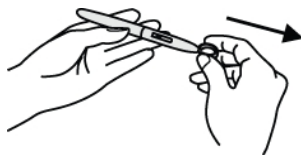

2. Push the new tip into the pen, and then press the pen tip down on a hard surface to secure.

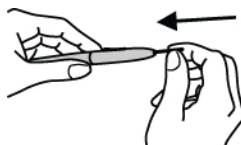

## Pairing an Additional Mimio Pad with the Wireless Receiver

### To pair an additional Mimio Pad with the wireless receiver

1. Plug the wireless receiver into a USB port on your computer.
2. Turn on the power to the Mimio Pad.
3. Simultaneously, press the learning button on the back of the Mimio Pad and the learning button on the wireless receiver.

The LCD screen on the Mimio Pad and the LED light on the wireless receiver will blink during the process. When the learning process is complete, the number on the LCD will show the number assigned to the additional pad (001 or greater).

This page intentionally left blank for double-sided printing.

# MimioStudio Recorder

MimioStudio Recorder can capture a live desktop, synchronized with audio, as a video file. You can save the file in two formats: Mimio and Microsoft. Both are AVI files, however, the Mimio format can only be played back using Mimio software. The Microsoft formatted AVI file can be played back in most Windows media players.





To import a video file you have already created elsewhere into MimioStudio Notebook, see Customizing the Content of the Gallery and Importing Gallery Items into a MimioStudio Notebook.

## Using MimioStudio Recorder

---

MimioStudio Recorder allows you to record your Mimio interactions as an AVI movie file with the option to record audio as well.

The following table shows several ways to access MimioStudio Recorder.

To start from	Do this
Taskbar	Right-click  , and then choose  <b>Recorder</b> .
Start Menu	Point to <b>Programs, MimioStudio, Tools</b> , and then choose <b>MimioStudio Recorder</b> .
MimioStudio Tools	Click the <b>Applications</b> button,  , and then choose  <b>Recorder</b> .



## Recording a Presentation



---

MimioStudio Recorder can be used to easily record presentations using the standard record, pause, stop, and play features.

### To start recording

1. Start MimioStudio Recorder.
2. Click the arrow to the right of the **Record** button, , and then choose a recording option from the list.

Option	Description
 <b>Record Desktop</b>	Records the entire desktop. (Default)
 <b>Record Window</b>	Records a specific window.
 <b>Record Area</b>	Records a selected area of the screen.

3. Just before you start your presentation, click the **Record** button, .
  - If you chose **Record Window**, select the window to record.
  - If you chose **Record Area**, drag a selection box around the area to record.
-  While recording, MimioStudio Recorder automatically minimizes and is displayed in the notification area of the taskbar as the MimioStudio Recorder icon, .



#### **To pause recording**

- ▶ Click  in the notification area of the taskbar.  
This pauses the recording and opens the MimioStudio Recorder window.

#### **To resume recording**

- ▶ Click the **Record** button, .

#### **To stop recording**

1. Click  in the notification area of the taskbar.  
This pauses the recording and opens the MimioStudio Recorder window.
2. Click the **Stop** button, .

#### **To preview a recording**

- ▶ Click the **Play** button, .  
Your default media player is started and your recording plays automatically.

-  Close your media player before starting a new recording.

#### **To save a recording**

1. Choose  **Save** from the **File** menu.
2. From the **Save As** dialog box, enter a name for the file in the **File name** box.
3. Click **Save**.



# Sharing the Whiteboard Remotely

This chapter describes how to share a presentation displayed on a Mimio-enabled whiteboard with Microsoft NetMeeting®. You can also share your desktop using various other desktop sharing solutions such as Windows® Meeting Space.

## Setting up MimioStudio with NetMeeting

---

MimioStudio is capable of automatically connecting your whiteboard to an open NetMeeting session. MimioStudio and NetMeeting can be used together in both Interactive and Recording modes.

### To use NetMeeting interactively

1. Start the NetMeeting application.  
Consult the Microsoft NetMeeting documentation if necessary.
2. Start MimioStudio in Interactive mode.  
See Setting Up Interactive Mode.
3. Use the MimioTeach stylus or Mimio Interactive mouse to select tools and add content directly onto the NetMeeting Whiteboard.

### To use NetMeeting with MimioCapture or Mimio Capture Kit

1. Start the NetMeeting application and the NetMeeting Whiteboard.  
Consult the Microsoft NetMeeting documentation if necessary.
2. Use the MimioCapture or Mimio Capture Kit pens and eraser on the Mimio-enabled whiteboard.  
Your content is shared on the NetMeeting Whiteboard.

## Adjusting the NetMeeting Settings

---

The NetMeeting settings allow you to enable/disable Microsoft NetMeeting support and adjust the device associated with the NetMeeting Whiteboard.

### To access the NetMeeting Settings

1. Start MimioStudio Settings.
2. Click  NetMeeting.

### To enable NetMeeting interaction

- ▶ Select the **Enable NetMeeting interaction** check box.

### To disable NetMeeting interaction

- ▶ Clear the **Enable NetMeeting interaction** check box.

**To set up NetMeeting support for a specific MimioClassroom device**







- ▶ Choose the device that you want to use with NetMeeting from the **Device** list.

## Chapter 12

# Customizing MimioStudio

This chapter describes the general features of MimioStudio Settings.

The following table shows several ways to access MimioStudio Settings.

To start from	Do this
Taskbar	Right-click  , and then choose  <b>Settings</b> .
MimioStudio Notebook	Do one of the following: <ul style="list-style-type: none"><li>▪ Double-click  on the status bar.</li><li>▪ Choose  <b>Settings</b> from the <b>Tools</b> menu.</li></ul>
MimioStudio Gradebook	Do one of the following: <ul style="list-style-type: none"><li>▪ Double-click  on the status bar.</li><li>▪ Choose  <b>Settings</b> from the <b>Tools</b> menu.</li></ul>

MimioStudio Settings contains options for setting and customizing the properties and characteristics of your MimioClassroom system, including Classroom Devices, Gradebook, Ink Capture, Interactive, Language, NetMeeting, Notebook, Recorder, and Vote.

### To change the settings

1. From the **MimioStudio Settings** dialog box, select the setting you want to change from the list on the left.
2. Make the changes you want to the settings.
  -  See later sections in this chapter for a complete description of all settings.
3. Click **Apply**.

## Adjusting the Classroom Devices Settings

The Classroom Devices settings displays a list of all MimioClassroom devices that are connected or are available to connect to your computer. You can connect to any available devices using the Classroom Devices settings.

### To connect to an available MimioClassroom device

1. Select the device to connect to from the **Devices** list.
2. Click **Connect**.

## Adjusting MimioStudio Gradebook Settings

MimioStudio Gradebook settings provides options for the appearance of student scores in the Gradebook.

The following table describes the MimioStudio Gradebook settings.

Setting	Description
Score Type	Choose to display student scores as percentages or points.
Decimal Places	Choose the number of decimal places to show in the score.

## Adjusting the Ink Capture Settings

---

The Ink Capture settings allow you to do the following:

- Change the surface size for a connected MimioTeach or Mimio Interactive device
- Change the mounting location for a Mimio Interactive device
- Change the width and color assignment for each MimioCapture or Mimio Capture Kit pen

These settings are only used when your MimioTeach or Mimio Interactive device is used to capture digital ink.

### To adjust the settings for a MimioTeach or Mimio Interactive device

1. Choose the device to adjust from the **Device** list.
2. Make the changes you want to the settings.
3. Click **Apply**.

### To adjust surface size for a MimioTeach or Mimio Interactive device

- ▶ Do one of the following:
  - Choose a size from the **Surface Size** list.
  - Choose **Custom** from the **Surface Size** list and enter the desired values into the **Width** and **Height** boxes.
  - Click **Auto Size** and touch a MimioCapture or Mimio Capture Kit pen at the location shown in the **Auto Size** dialog box.

### To adjust the mounting location for a Mimio Interactive bar

- ▶ Choose a mounting location from the **Device Mounting** list.
  -  The sensors on the Mimio Interactive bar must point in toward the writing surface.

<b>Location</b>	<b>Description</b>
<b>Vertical – Top Left</b> <i>Default</i>	The Mimio Interactive bar is mounted vertically and aligned with the top left corner of the whiteboard (maximum size is 4' tall x 8' wide).
<b>Vertical – Top Right</b>	The Mimio Interactive bar is mounted vertically and aligned with the top right corner of the whiteboard (maximum size is 4' tall x 8' wide).
<b>Vertical – Bottom Left</b>	The Mimio Interactive bar is mounted vertically and aligned with the bottom left corner of the whiteboard (maximum size is 4' tall x 8' wide).
<b>Vertical – Bottom Right</b>	The Mimio Interactive bar is mounted vertically and aligned with the bottom right corner of the whiteboard (maximum size is 4' tall x 8' wide).
<b>Horizontal – Top Left</b>	The Mimio Interactive bar is mounted horizontally and aligned with the top left corner of the whiteboard (maximum size is 8' tall x 4' wide).
<b>Horizontal – Top Right</b>	The Mimio Interactive bar is mounted horizontally and aligned with the top right corner of the whiteboard (maximum size is 8' tall x 4' wide).
<b>Horizontal – Bottom Left</b>	The Mimio Interactive bar is mounted horizontally and aligned with the bottom left corner of the whiteboard (maximum size is 8' tall x 4' wide).
<b>Horizontal – Bottom Right</b>	The Mimio Interactive bar is mounted horizontally and aligned with the bottom right corner of the whiteboard (maximum size is 8' tall x 4' wide).

 This feature is not necessary for MimioTeach. When using MimioTeach with MimioCapture, the MimioTeach bar is always attached to the MimioCapture tray. When using MimioTeach without MimioCapture, the MimioTeach bar can be mounted anywhere on the whiteboard.

#### **To adjust the pen settings**

1. Click **Pens**.  
The Pens dialog box appears.
2. Choose the MimioCapture or Mimio Capture Kit pen to adjust from the **Pen** list.
3. To adjust the line thickness of the pen, drag the **Pen Width** slider.  
Alternately, enter a value into the **Pen Width** box.
4. To adjust the pen color, select a color from the **Pen Color** palette.  
For additional color choices, click **More Colors**.
5. Click **OK**.

#### **To view device information**

- ▶ Click **Settings**.

The dialog box appears showing the device information, environmental analysis, and device memory.

**To reset to the default device settings**

- ▶ Click **Defaults**.

## Adjusting the Interactive Settings

---

The Interactive settings allow you to calibrate or enable (if calibration has already been done) Interactive mode. The Interactive settings also contain settings for changing the functions of the MimioTeach stylus, Mimio Interactive mouse, MimioTeach bar, MimioCapture tray buttons, and Mimio Interactive bar buttons.

### General Settings

Setting	Description
<b>Use previous calibration</b>	Prevents you from having to calibrate each time you start Interactive mode. Select this setting if you have a permanently installed whiteboard and projector.
<b>Automatically enable when a device is detected</b>	Automatically starts Interactive mode when a MimioTeach or Mimio Interactive bar is connected to your computer.

### Actions and Commands Settings

Setting	Description
<b>Action</b>	List of the MimioTeach stylus, Mimio Interactive mouse, MimioTeach bar, Mimio Interactive bar, and MimioCapture tray buttons.
<b>Function</b>	List of the functions that you can associate with a MimioTeach stylus, Mimio Interactive mouse, MimioTeach bar, Mimio Interactive bar, or MimioCapture tray button.

## Adjusting the Language Settings

---

You can change the display language for MimioStudio software so that you can work in a language that is most familiar to you.

**To adjust the language**

1. Choose a language from the **Language** list.
2. Click **Apply**.  
The MimioStudio dialog box appears.
3. Click **Yes** to restart MimioStudio in the selected language.

## Adjusting MimioStudio Notebook Settings

MimioStudio Notebook settings provides options for setting the general parameters of MimioStudio and the default interaction mode with MimioClassroom devices.

The following tables describe the MimioStudio Notebook settings.

### General Settings

Setting	Description
<b>Enable audio feedback</b>	Enables sound from a Mimio device when buttons are pressed or the device is connected or disconnected from the computer.
<b>Enable smooth ink, objects and text</b>	Enables smooth or anti-aliased ink, objects, and text. Disabling this setting can increase the performance of the application.
<b>Enable auto recovery</b>	Enables the automatic recovery of data if MimioStudio quits unexpectedly. When this setting is enabled, MimioStudio Notebook saves ink data to a backup file every 10 minutes.
<b>Enable trashcan</b>	Places the trashcan on the MimioStudio Notebook as an easy method for deleting content.
<b>Enable fullscreen border (Screen Annotation only)</b>	Enables the border during Screen Annotation mode. See Marking Up the Display Using Screen Annotations.

### Ink Capture Settings

Setting	Description
<b>Connect to available device on file new</b>	Automatically connect devices to newly opened Notebook.
<b>Connect to device when any pen is used</b>	Automatically open a Notebook in Ink Capture mode when a MimioCapture or Mimio Capture Kit pen touches the whiteboard.
<b>Download data when local storage is detected (Mimio Interactive only)</b>	Automatically download digital ink to a new MimioStudio Notebook when a Mimio Interactive device is detected by your computer.
<b>Clear local storage after successful download (Mimio Interactive only)</b>	Automatically clear digital ink from a Mimio Interactive device after the information is downloaded to a MimioStudio Notebook.

## Adjusting MimioStudio Recorder Settings

---

The MimioStudio Recorder settings allow you to adjust the video and audio quality used for recording sessions.

The following table describes the MimioStudio Recorder settings.

Setting	Description
Video Quality	Choose the quality to use to record video.
Audio Quality	Choose the quality to use to record audio.
Video Format	Choose the format for recording a movie.

## Adjusting the Vote Settings

---

The following table describes the MimioStudio Vote settings.

Setting	Description
Buttons	Select to have each MimioVote unit button illuminated with a different color or to have all the buttons illuminated with a single color.
Display student scores on handheld units	Select this check box to have the student score displayed on each student's MimioVote unit once the student has completed a self-paced activity.
Store screen snapshot with question	Select this check box to save a screen shot with each question polled using MimioStudio Quick Vote.



## Chapter 13

# Getting Help

This chapter describes how to check for and install software updates, and how to troubleshoot some common problems.

If you are unable to solve a problem, this chapter also describes how to contact DYMO Technical Support.

### Updating the Software

---

The Software Update settings allow you to check for and install MimioStudio software updates.

You must be connected to the Internet to check for updates.

#### To check for software updates

1. Start MimioStudio Settings.
2. Select  **Software Update**.
3. Click **Check for Updates**.

A list of available updates is displayed.

#### To turn on automatic update notification

- ▶ Select the **Notify me when updates are available** check box, and then click **OK**.

#### To install software updates

1. Select the updates you want to install.
2. Click **Install**.

### Troubleshooting

---

#### To test for environmental interference

1. Start MimioStudio Settings.
2. Select  **Ink Capture**, and then click **Settings**.
3. Under **Environmental Analysis**, click **Test**.

### Contacting DYMO

---

DYMO maintains an Internet Web site that offers support for MimioClassroom products. In addition, DYMO's Technical Support department is available by phone.

**Web site:** [www.mimio.dymo.com](http://www.mimio.dymo.com)

**Phone:** (877) 846-3721

Visit the Support section of our Web site at [www.mimio.dymo.com](http://www.mimio.dymo.com) to contact us by email.

This page intentionally left blank for double-sided printing.

## Chapter 14

# Technical and Environmental Information

This chapter contains technical information for the MimioClassroom products.

For product specifications and compliance information, visit the Documentation section of the Support area of our Web site at [www.mimio.dymo.com](http://www.mimio.dymo.com).

### **Environmental Information**

---

The equipment that you bought has required the extraction and use of natural resources for its production. It may contain hazardous substances for the health and the environment.

In order to avoid the dissemination of those substances in our environment and to diminish the pressure on the natural resources, we encourage you to use the appropriate take-back systems.

Those systems will reuse or recycle most of the materials of your end life equipment in a sound way.

The crossed-bin symbol marked in your device invites you to use those systems.



If you need more information on the collection, reuse and recycling systems, please contact your local or regional waste administration.

You can also contact DYMO for more information on the environmental performances of our products.

### **Safety Precautions for Lithium-Ion Rechargeable Batteries**

---

Inaccurate handling of a Lithium-ion rechargeable battery may cause leakage, heat, smoke, an explosion, or fire. This could cause deterioration of performance or failure. This may also damage the protection device installed in the battery pack. This could damage equipment or injure users. Thoroughly follow the instructions below.

## While Charging

---



### Danger

- When charging the battery, use dedicated chargers and follow the specified conditions.
- Do not connect directly to an electric outlet or cigarette lighter charger.
- Do not use or store battery close to fire or inside the car where temperature may be over 60°C.



### Warning

- Stop charging the battery if charging is not completed within the specified time.



### Caution

- Thoroughly read this user guide before charging the battery.
- Do not charge in a place that generates static electricity.
- Battery can only be charged within 0°C~45°C temperature range.

## When Discharging the Battery

---



### Danger

- Use the battery only in the specified equipment.
- Do not use or store battery close to fire or inside the car where temperature may be over 60°C.



### Caution

- Do not charge in a place that generates static electricity.
- Battery can only be used within -20°C~60°C temperature range.

## Documentation Feedback

---

We are constantly working to produce the highest quality documentation for our products. We welcome your feedback. Send us your comments or suggestions about our online Help, printed, or PDF manuals.

Please include the following information with your feedback:

- Product name and version number
- Type of document: printed manual, PDF, or online Help
- Topic title (for online Help) or page number (for printed or PDF manuals)
- Brief description of content (for example, step-by-step instructions that are inaccurate, information that requires clarification, areas where more detail is needed, and so on)
- Suggestions for how to correct or improve the documentation

We also welcome your suggestions for additional topics you would like to see covered in the documentation.

Send email feedback to:

documentation@dymo.com

Please keep in mind that this email address is only for documentation feedback. If you have a technical question, please contact Customer Service.

This page intentionally left blank for double-sided printing.