

Mimio®
Interactive Teaching Technologies

MimioClassroom User Guide for Windows®



mimio.dymo.com

© 2010 Sanford, L.P. All rights reserved. Revised 10/21/2010.

No part of this document or the software may be reproduced or transmitted in any form or by any means or translated into another language without the prior written consent of Sanford, L.P.

Mimio, MimioClassroom, MimioTeach, MimioCapture, MimioVote, MimioView, MimioHub, and MimioStudio are registered marks in the United States and other countries. All other trademarks are the property of their respective holders.

Contents

About MimioClassroom	1
MimioStudio.....	1
MimioTeach.....	1
MimioCapture.....	1
MimioVote.....	2
MimioView.....	2
Minimum System Requirements.....	2
Using this Guide.....	2
MimioStudio	5
About MimioStudio.....	5
About MimioStudio Notebook.....	6
About MimioStudio Tools.....	7
About MimioStudio Gallery.....	7
Getting Started with MimioStudio.....	9
Accessing MimioStudio Notebook.....	9
Accessing MimioStudio Tools.....	9
Accessing MimioStudio Gallery.....	9
Using MimioStudio Notebook.....	10
Working with Pages.....	10
Attaching Files.....	13
Using MimioStudio Tools.....	13
Creating Objects.....	13
Importing a Picture, Multimedia Object, or Document.....	15
Manipulating Objects.....	16
Adding Actions to Objects.....	19
Using MimioStudio Gallery.....	20
Importing Gallery Items into a Notebook.....	21
Customizing the Content of the Gallery.....	21
Exporting a Gallery Folder to a Gallery File.....	23
Working with Saved Annotation Snapshots.....	23
Viewing Screen Annotation Snapshots.....	23
Renaming an Annotation Snapshot.....	24
Adding Keywords to an Annotation Snapshot.....	24
Searching for an Annotation Snapshot.....	24
Importing an Annotation Snapshot.....	24

Pasting an Annotation Snapshot Into Another Application.....	24
Printing Annotation Snapshots.....	25
Deleting Annotation Snapshots.....	25
Delivering Interactive Notebook Lessons and Presentations.....	25
Using Fullscreen View.....	25
Navigating Through a Presentation.....	25
Working with Multimedia Objects.....	26
MimioTeach	27
What's Included.....	27
About MimioTeach.....	27
Status Lights.....	28
About MimioStudio Tools.....	28
Getting Started.....	29
Setting Up the MimioTeach Stylus.....	29
Setting Up the MimioTeach Bar.....	30
Setting Up Interactive Mode.....	32
Projecting Your Desktop.....	32
Calibrating Interactive Mode.....	32
Using MimioTeach.....	33
Using the MimioTeach Stylus.....	33
Focusing Attention Using the Reveal and Spotlight Tools.....	34
Using the Reveal Tool.....	34
Using the Spotlight Tool.....	34
Marking Up the Display Using Screen Annotations.....	35
Enabling Screen Annotation Mode.....	35
Annotating the Screen Using MimioStudio Tools.....	36
Clearing All Annotations from the Display.....	38
Inserting Text Into an Application Using MimioStudio Text Tools.....	38
Using the On-Screen Keyboard.....	39
Using Write Anywhere.....	39
Using Writing Pad.....	40
Using Gesture Recognition.....	40
Using the Web Browser, Calculator, and Magnify Tools.....	41
Recording Desktop Actions and Audio in Interactive Mode.....	41
Caring for MimioTeach.....	41
Cleaning MimioTeach.....	42
Inserting the Batteries.....	42
Mounting MimioTeach to a Non-Magnetic Whiteboard.....	42

MimioCapture	45
What's Included.....	45
About MimioCapture.....	45
Status Lights.....	46
About MimioStudio Notebook.....	46
Getting Started.....	47
Setting Up the MimioCapture Tray.....	47
Setting Up the MimioCapture Pens.....	49
Setting Up the MimioCapture Eraser.....	50
Charging the Pens and Eraser.....	50
Setting Up MimioStudio Notebook for Capture.....	50
Setting the Whiteboard Size.....	51
Starting Ink Capture Mode.....	51
Using MimioCapture.....	51
Capturing Digital Ink.....	51
Writing and Drawing Digital Ink.....	51
Adding, Copying, and Printing Notebook Pages.....	52
Caring for MimioCapture.....	53
Cleaning MimioCapture.....	53
Mounting MimioCapture to a Non-Magnetic Whiteboard.....	53
MimioVote	55
What's Included.....	55
About MimioVote.....	55
About the MimioVote Station.....	55
Status Lights.....	56
About the MimioVote Units.....	56
About the Software.....	57
About MimioStudio Notebook.....	57
About the Vote Toolbar.....	58
About MimioStudio Quick Vote.....	59
About MimioStudio Gradebook.....	59
Classes View.....	59
Class View.....	60
Date View.....	61
Activity View.....	62
Student Pane.....	63
Getting Started.....	64
Setting Up MimioVote.....	64

Adding a Second MimioVote System.....	66
Using MimioStudio Gradebook.....	66
Setting Up the Gradebook.....	66
Creating a Class.....	67
Adding Students.....	67
Importing a List of Students.....	67
Adding Activities.....	68
Modifying the Gradebook.....	68
Editing Student Information.....	68
Removing a Student.....	68
Editing Activities.....	69
Editing Questions.....	69
Generating Reports.....	69
Exporting a List of Students.....	70
Archiving Classes.....	70
Exporting Results.....	70
Opening Archived Classes.....	71
Creating Activities.....	71
Creating Activities in Notebook.....	71
Creating Activities in PowerPoint®.....	72
Modifying Question Objects.....	72
Importing Standard Assessments.....	73
Printing Activities.....	73
Using the MimioVote Unit.....	73
Answering Questions.....	74
Answering Questions for Teacher-Led Activities.....	74
Answering Questions for Self-Paced Activities.....	74
Requesting Help.....	74
Using the Vote Toolbar.....	75
Taking Attendance.....	75
Using the Timer.....	75
Conducting Activities.....	75
Conducting a Teacher-Led Activity.....	75
Asking Questions Using Quick Vote.....	76
Conducting a Self-Paced Activity.....	76
Viewing Question Results.....	77
Viewing Activity Results.....	77
Viewing a List of Students that Have Not Responded.....	77
Viewing Requests for Help.....	78

Caring For MimioVote.....	78
Cleaning MimioVote.....	78
Storing MimioVote.....	78
MimioView.....	79
What's Included.....	79
About MimioView.....	79
Status Lights.....	80
About MimioStudio View.....	80
Getting Started.....	81
Installing MimioView.....	81
Opening the View Window.....	82
Closing the View Window.....	82
Using MimioView.....	82
Displaying an Image.....	82
Displaying a Document.....	82
Displaying an Object.....	83
Displaying a Microscope Slide.....	83
Freezing the Image.....	83
Adjusting the Image.....	84
Rotating the Image.....	84
Zooming the Image.....	84
Adjusting the Settings.....	85
Annotating an Image.....	85
Clearing All Annotations from the Image.....	85
Transferring an Image.....	86
Recording Video.....	86
Turning Off the Lamps.....	86
Caring For MimioView.....	86
Cleaning MimioView.....	86
Mounting MimioView Permanently.....	87
MimioStudio Recorder.....	89
Using MimioStudio Recorder.....	89
Recording a Presentation.....	89
Sharing the Whiteboard Remotely.....	91
Setting up MimioStudio with NetMeeting.....	91
Adjusting the NetMeeting Settings.....	91
Customizing MimioStudio.....	93

Adjusting the Classroom Devices Settings.....	93
Adjusting the Ink Capture Settings.....	93
Adjusting the Interactive Settings.....	95
General Settings.....	95
Actions and Commands Settings.....	95
Adjusting the Language Settings.....	95
Adjusting MimioStudio Notebook Settings.....	95
General Settings.....	96
Ink Capture Settings.....	96
Adjusting MimioStudio Recorder Settings.....	96
Adjusting the Vote Settings.....	96
Getting Help.....	99
Updating the Software.....	99
Troubleshooting.....	99
Contacting DYMO.....	99
Technical and Environmental Information.....	101
Technical Specifications.....	101
MimioView.....	101
Declaration of Conformity.....	101
United States and Canada.....	102
MimioTeach, MimioCapture, and MimioVote.....	102
MimioView.....	102
European Union.....	103
MimioTeach.....	103
MimioCapture.....	104
MimioVote.....	104
MimioView.....	105
Environmental Information.....	105
Safety Precautions for Lithium-Ion Rechargeable Batteries.....	105
Documentation Feedback.....	106

About MimioClassroom

MimioClassroom is a suite of tools for capturing, creating, and presenting information.

The following MimioClassroom components are described in this User Guide:

- MimioStudio
- MimioTeach
- MimioCapture
- MimioVote
- MimioView

MimioStudio

MimioStudio software includes all of the tools you need to make the most out of your MimioClassroom devices. You can also use the MimioStudio software without a MimioClassroom device to prepare presentations and manipulate previously created content.

MimioStudio Notebook provides a multi-page workspace for creating lessons and presentations. Using the MimioStudio Notebook is very similar to using other word processing or presentation software applications.

MimioStudio Notebook provides multiple authoring and editing tools for creating almost any type of content. You can use Notebook with MimioStudio Tools to create a variety of objects including text boxes, freehand writing and drawing, lines, arrows, and many basic shapes. Images can be imported into a Notebook, both as objects and as background images.

MimioTeach

Using MimioTeach with a projector, you can deliver lessons and presentations directly from your whiteboard. Using MimioStudio Interactive mode, you control the movement of the cursor on your screen with the MimioTeach stylus, much like you would with a mouse at your computer.

MimioCapture

MimioCapture is used with a MimioTeach-enabled whiteboard to record notes and drawings from your whiteboard. Using MimioStudio Ink Capture mode, you make notes and drawings on your whiteboard using the MimioCapture pens. Your notes are automatically captured in a MimioStudio Notebook.

MimioVote

MimioVote is a wireless, interactive, student response system. Using MimioVote, you can easily and quickly gather student responses. This quick feedback from students allows you to make sure each student is keeping up and adjust your lesson accordingly.

MimioView

MimioView works seamlessly with MimioStudio software to display documents, three-dimensional objects, and microscope slides for your entire class to view. You can use MimioView to display still images or live video.

Minimum System Requirements

The minimum system requirements for MimioStudio are:

- Microsoft Windows®-compatible computer with a Pentium II, 750 MHz processor
- Microsoft Windows XP SP2, Microsoft Vista®, or Microsoft Windows 7 operating system
- 512 MB RAM minimum (1 GB RAM recommended)
- 250 MB free disk space (English), 350 MB free disk space (International)
- CD-ROM drive or Internet connection to download the software
- Available USB port (required to use a MimioClassroom device)

Using this Guide

This User Guide includes information for using the different MimioClassroom components. Depending on the types of MimioClassroom devices you have, some sections of this User Guide may not apply to you.

The following table provides a summary of the contents.

User Guide Chapter	Description
About MimioClassroom	This chapter gives an overview of the MimioClassroom products, including MimioStudio software, MimioTeach, MimioCapture, MimioVote, and MimioView.
MimioStudio	This chapter describes how to work with MimioStudio Notebook, Tools, and Gallery to create and deliver lessons and other presentations.
MimioTeach	This chapter describes how to set up and use MimioTeach with your whiteboard and a projector. This chapter also describes how to use MimioStudio in Interactive mode.
MimioCapture	This chapter describes how to set up and use MimioCapture. Included in this chapter are instructions for capturing notes and drawings from a MimioTeach-enabled whiteboard as digital ink using MimioCapture.
MimioVote	This chapter describes how to set up and use MimioVote. Included in this chapter are instructions for creating and conducting MimioVote activities, as well as information about setting up and using MimioStudio Gradebook to save student grades and information.
MimioView	This chapter describes how to set up and use MimioView. Included in this chapter are instructions for displaying and annotating images in the MimioStudio View window.
Using MimioStudio Recorder	This chapter describes how to use MimioStudio Recorder to create movies (with audio) of your presentations.
Sharing the Whiteboard Remotely	This chapter describes how to share your MimioTeach-enabled whiteboard using Microsoft NetMeeting.
Customizing MimioStudio	This chapter describes how to customize the features of the MimioStudio software and the MimioClassroom devices.
Getting Help	This chapter gives troubleshooting information for some common problems, describes how to check for and install MimioStudio software updates, and describes how to contact Technical Support.
Technical and Environmental Information	This chapter contains technical, certification, and safety information for the MimioClassroom products.

This page intentionally left blank for double-sided printing.

Chapter 2

MimioStudio

MimioStudio software includes all of the tools you need to make the most out of your MimioClassroom devices. You can also use the MimioStudio software without a MimioClassroom device to prepare presentations and manipulate previously created content.

About MimioStudio

The following are the three main MimioStudio software applications that are used to create and present information.

- MimioStudio Notebook
- MimioStudio Tools
- MimioStudio Gallery

 For information about other MimioStudio applications, see the chapters of this User Guide that describe the MimioClassroom devices that you have.

MimioStudio Notebook provides a multi-page workspace for creating lessons and presentations. Using the MimioStudio Notebook is very similar to using other word processing or presentation software applications.

MimioStudio Notebook provides multiple authoring and editing tools for creating almost any type of content. You can use Notebook with MimioStudio Tools to create a variety of objects including text boxes, freehand writing and drawing, lines, arrows, and many basic shapes. Images can be imported into a Notebook, both as objects and as background images.

The following figure shows the major components of MimioStudio software.

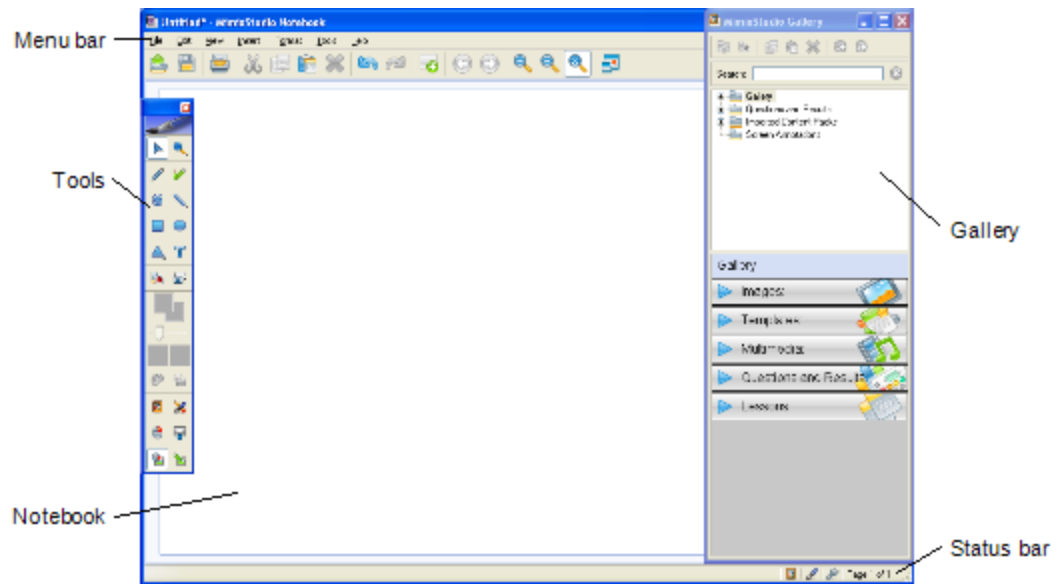

About MimioStudio Notebook

You can create and present information with MimioStudio Notebook. Using Notebook is very similar to using other word processing or presentation software. Content created in Notebook can be saved as Mimio INK files or a variety of other file formats including HTML, JPEG, PNG, GIF, BMP, TIF, WMF, EMF, and PDF.

You can use Tab View to view a list of files that are attached to a Notebook or to view a thumbnail of each page in a Notebook.

The following figure shows the MimioStudio Notebook.

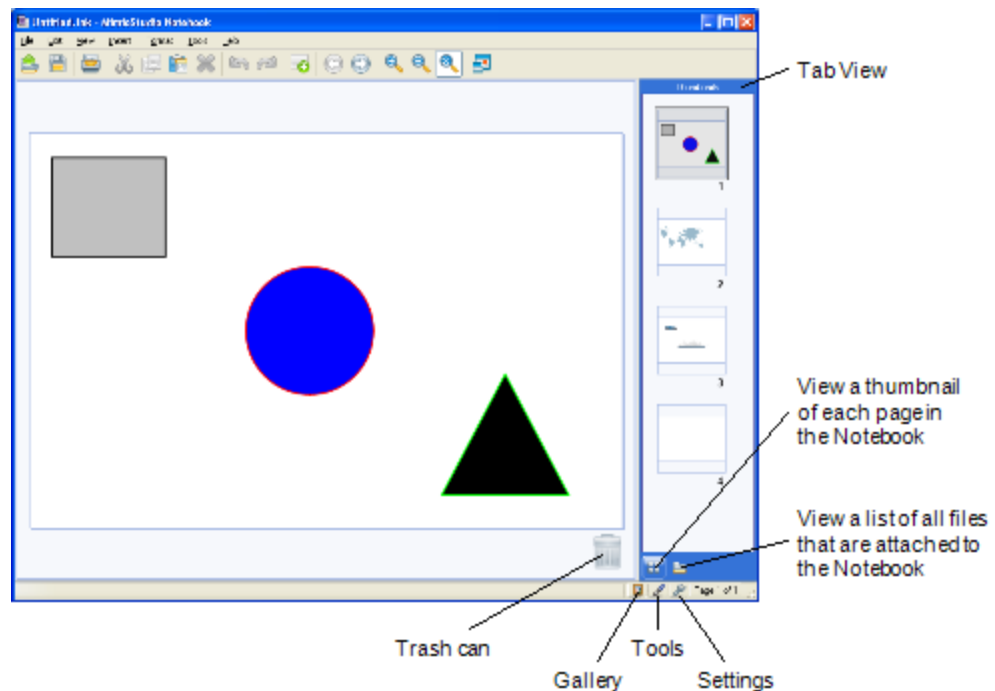

About MimioStudio Tools

MimioStudio Tools provides a comprehensive set of interactive tools and resources to create and present information. MimioStudio Tools is used to modify MimioStudio Notebook pages and to make screen annotations on the whiteboard.

The following figure shows the MimioStudio Tools toolbar.

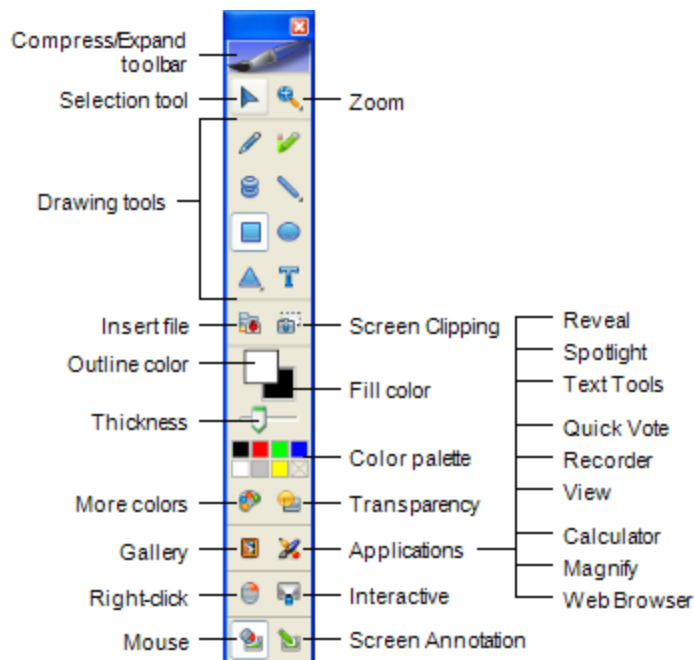

MimioStudio Tools has two views: a fully expanded view, for easy access to all features, and a compressed view, which takes up less space on the screen.

To compress and expand MimioStudio Tools

- ▶ Double-click  at the top of the MimioStudio Tools toolbar.

About MimioStudio Gallery

MimioStudio Gallery contains elements that can be used to create your lessons and presentations, such as images, templates, movies, and previously created lessons. MimioStudio Gallery also contains Screen Annotation snapshots. You can customize the Gallery by adding your own elements.

The following figure shows the MimioStudio Gallery.

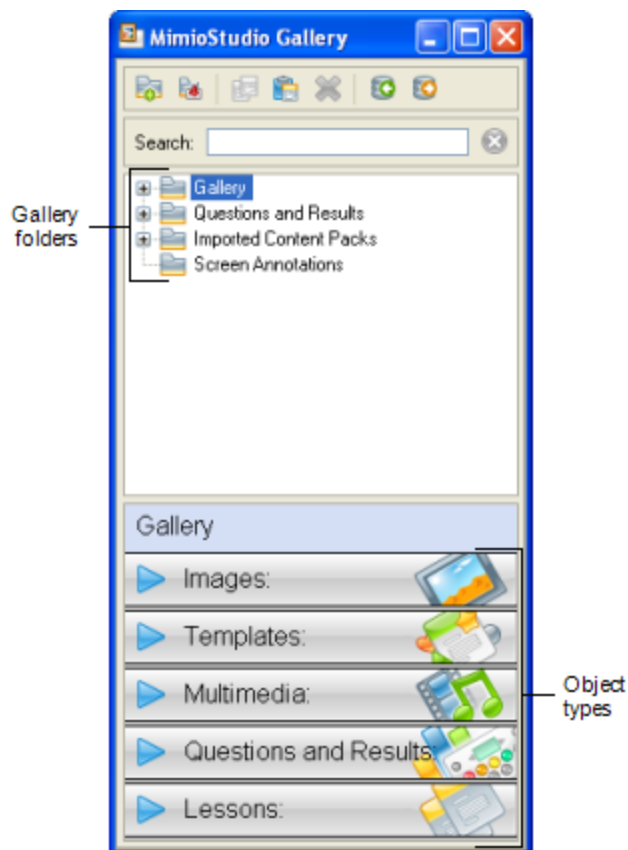

MimioStudio Gallery consists of the following four main folders:

- **Screen Annotations** - contains all saved Screen Annotation snapshots.
- **Imported Content Packs** - contains any imported content that you have not yet added to the Gallery folder.
- **Questions and Results** - contains a variety of objects for use with MimioVote.
- **Gallery** - contains a number of different folders used to categorize items, such as Geography, Mathematics, and so on.

The Gallery folder and subfolders can contain five different types of objects:

- **Images** - Images include pictures and graphics.
- **Templates** - Templates include backgrounds and predefined page layouts.
- **Multimedia** - Multimedia objects include movies, animation, and sound.
- **Questions and Results** - Questions and Results include objects for creating and displaying the results of MimioVote activities.
 - This section of the Gallery does not appear until you move objects from the Questions and Results folder to the Gallery folder or a Gallery subfolder.
- **Lessons** - Lessons include lessons created using MimioStudio Notebook and imported documents. You can create your own lessons or import lessons created by someone else.



Getting Started with MimioStudio

After installing MimioStudio, MimioStudio Notebook and MimioStudio Tools open on your desktop.

You can access many of the features in MimioStudio in several ways; from the menu bar, the MimioStudio Tools buttons, and the right-click menus. The available features change depending on what you are doing in the software. Be sure to explore the right-click menu options as you work with MimioStudio.







Accessing MimioStudio Notebook

Several ways to access MimioStudio Notebook are shown in the following table.

To start from the	Do this
Desktop	Double-click  on the desktop.
Taskbar	Right-click  , and then choose  Notebook .
Start menu	Point to Programs, MimioStudio , and then choose MimioStudio Notebook .



Accessing MimioStudio Tools

Several ways to access MimioStudio Tools are shown in the following table.

To start from the	Do this
Desktop	Double-click  on the desktop.
Taskbar	Right-click  , and then choose  Tools .
StartMenu	Point to Programs, MimioStudio , and then choose MimioStudio Tools .
MimioStudio Notebook	Do one of the following: <ul style="list-style-type: none"> ▪ Double-click  on the status bar. ▪ Choose  MimioStudio Tools from the Tools menu.
MimioTeach	Press the Launch button,  , on the MimioTeach bar, and then click  Tools in the Launch window.

Accessing MimioStudio Gallery

Several ways to access MimioStudio Gallery are shown in the following table.

To start from	Do this
StartMenu	Point to Programs , MimioStudio , Tools , and then choose MimioStudio Gallery .
MimioStudio Tools	Click  on the MimioStudio Tools toolbar.
MimioStudio Notebook	Do one of the following: <ul style="list-style-type: none"> ▪ Double-click  on the status bar. ▪ Choose  Gallery from the Insert menu.

Using MimioStudio Notebook

You can create and present information with MimioStudio Notebook. Using Notebook is very similar to using other word processing or presentation software. Content created in Notebook can be saved as Mimio INK files or a variety of other file formats including HTML, JPEG, PNG, GIF, BMP, TIF, WMF, EMF, and PDF.

You can use Tab View to view a list of files that are attached to a Notebook or to view a thumbnail of each page in a Notebook.

To open an existing Notebook

1. Start MimioStudio Notebook and click .
2. From the **Open** dialog box, navigate to and select the file to open and click **Open**.

To save a Notebook

1. Click the **Save** button, .
2. From the **Save As** dialog box, enter a name for your file in the **File name** box.
3. Choose the desired format from the **Save as type** list.
4. Click **Save**.

When saving in a format other than INK, the Select Pages dialog box appears.



5. From the Select Pages dialog box, do the following:
 - Select the pages to save under **Page Selection**.
 - Choose a size for the images from the **Size** list.
6. Click **OK**.

Working with Pages

Each lesson or presentation created in MimioStudio Notebook consists of a series of pages. Pages can be viewed, presented, and edited in the main Notebook window or in Full Screen view. You can view a thumbnail of each page in a Notebook using the Thumbnails pane in the Tab View.

You can insert new pages, import pages from another Notebook, delete pages, and reorder pages. You can also change the size of a page, change the background of a page, and add transition effects between pages in your Notebook.



To insert a new page

- ▶ Do one of the following:
 - Click the **New Page** button, .
 - (*Capture mode only*) Press the **New Page** button, , on your MimioCapture tray.



To select a page

1. In the Tab View, click  to display the **Thumbnails** pane.
2. Do one of the following:
 - To select multiple pages, press CTRL and select each page.
 - To select multiple pages that are close to each other, drag a selection rectangle over the pages to select.
 - To select a range of pages, select the first page, and then press **SHIFT** and select the last page.
 - To select all pages, choose **Select All** from the **Edit** menu.





To insert a duplicate of an existing page

1. In the Tab View, click , and then select the page to duplicate.
2. Do one of the following:
 - Choose **Duplicate Page** from the **Insert** menu.
 - (*Capture mode only*) Press the **Copy Page** button, , on your MimioCapture tray.

To delete a page

1. In the Tab View, click , and then select the page to delete.
2. Click the **Delete** button, .

To import a page from another Notebook

1. In the Tab View of the source Notebook, click  and then select the page to import.
 2. Click the **Copy** button, .
 3. Select the location in the target Notebook to insert the page.
 4. Click the **Paste** button, .
-  You can also import pages by dragging the pages from the source Notebook to the target Notebook.

To insert the desktop as a new page

1. From MimioStudio Tools, click the **Screen Clipping** button, . The desktop is displayed with a transparent mask.
2. Click the text **Click here to capture this Desktop as a New Page**. The desktop is inserted as a new page in the Notebook.

To change the page size

1. Choose **Page Setup** from the **File** menu. The Page Setup dialog box appears.
2. Do one of the following:
 - From the **Page Size** list, choose any of the available display or device sizes.
 - From the **Page Size** list, choose **Custom**, and then enter the desired valued into the **Width** and **Height** boxes.

3. From the **Apply To** list, choose one of the following:
 - **Current Page** to apply the page size to the current page only.
This option is not available if more than one page is selected in the Tab View.
 - **Selected Pages** to apply the page size to the selected pages.
This option is only available if more than one page is selected in the Tab View.
 - **Whole Document** to apply the page size to all of the pages in the Notebook.
4. (Optional) Do one of the following:
 - To apply the page size to all new pages, select the **All new pages** check box.
This option is only available if no MimioTeach device is connected.
 - To apply the page size to all new pages and the currently connected device, select the **The connected device** check box.
This option is only available if a MimioTeach device is connected.
5. Click **OK** to apply your changes.

To change the background color of a page

1. Choose **Background** from the **Insert** menu.
2. From the **Background** dialog box, click **Color**.
3. From the **Color** dialog box, select a color, and then click **OK**.
4. From the **Apply To** list, select the pages to apply the background color to.
5. To apply the background color to all new pages, select the **All new pages** check box.
6. Click **OK** to apply your changes.

To change the background image of a page

1. Choose **Background** from the **Insert** menu.
2. From the **Background** dialog box, click **Image**.
3. From the **Open** dialog box, navigate to and select the image file that you want to use as your background.
4. Click **Open**.

The image is displayed in the **Preview** area.

 You can also import an image from another application or from the MimioStudio Gallery to use as a background. To do this, select the image and drag to the **Preview** area.

5. Select the display mode for the new background from the **Mode** list.

Mode	Result
Place	The image is placed in the top left corner of the page and is not resized.
Stretch	The image is resized to fill the entire page.
Tile	The image is tiled repeatedly to fill the entire page and is not resized.
Center	The image is placed in the center of the page and is not resized.

6. From the **Apply To** list, select the pages to apply the background to.

7. To apply the background to all new pages, select the **All new pages** check box.
8. Click **OK** to apply your changes.





To add a transition effect between pages

1. Choose **Page Transition** from the **Insert** menu.
The Page Transition dialog box appears.
2. From the **Transitions** list, select the transition to apply.
3. From the **Apply To** list, select the pages to apply the transition to.
4. To apply the transition to all new pages, select the **All new pages** check box.
5. Click **OK**.

To sort pages

1. In the Tab View, click  to display the **Thumbnails** pane.
2. Select the pages to sort.
3. Drag the selected pages to the desired location.

To print a page

1. In the Tab View, click  to display the **Thumbnails** pane.
 2. Select the pages to print.
 3. Click the **Print** button, .
-  To print the current page in Ink Capture mode, press the **Print Page** button, , on your MimioCapture tray.

Attaching Files

You can attach any type of file to a MimioStudio Notebook. Once a file is attached to the Notebook, you can quickly open the file directly from within MimioStudio Notebook.

To attach a file to a Notebook

1. In the Tab View, click  to display the **File Attachment** pane.
2. On your computer, navigate to and select the file to attach to the Notebook.
3. Drag the file to the **File Attachment** pane.
The file is attached to the Notebook.

To open an attached file

1. In the Tab View, click  to display the **File Attachment** pane.
2. Double-click the file to open.

Using MimioStudio Tools

Using MimioStudio Tools, you can create a wide variety of objects on any MimioStudio Notebook page, including lines, shapes, and freehand drawing and writing.

See Accessing MimioStudio Tools for information on accessing MimioStudio Tools.

Creating Objects

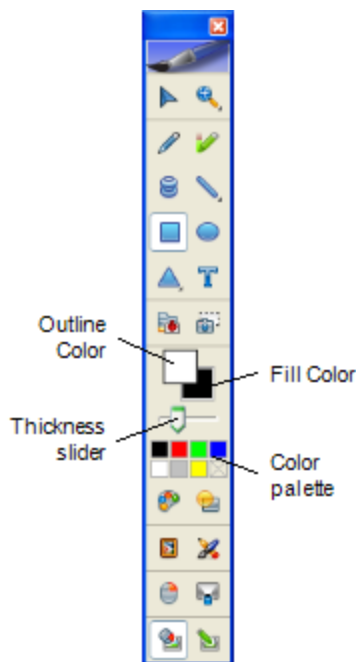

MimioStudio Tools provides tools for inserting freehand writing or drawing into your MimioStudio Notebook, as well as lines, arrows, basic shapes, and formatted text. You can

also import images and multimedia objects, or insert a clipping of your screen into your Notebook using Tools.





Once you select a drawing tool, that tool remains selected until you select a different drawing tool or the selection tool.

To use the freehand pen

1. Click the **Pen** button, .
2. (Optional) To adjust the line width, drag the Thickness slider.
3. (Optional) To adjust the line color, select a color from the Color Palette.
For additional color choices click .
4. (Optional) To adjust the transparency of the line, click the **Transparency** button, , and then choose a transparency percentage.
5. Place the cursor where you want the ink stroke to start on the page.
6. Drag the cursor to draw ink strokes.





To highlight a portion of the display

1. Click the **Highlighter** button, .
2. (Optional) To adjust the highlighter width, drag the Thickness slider.
3. (Optional) To change the color, select a color from the Color Palette.
For additional color choices click .
4. Place the cursor where you want the highlight stroke to start on the page.
5. Drag the cursor over the area you want to highlight.









To erase ink and highlighting

1. Click the **Eraser** button, .
2. (Optional) To adjust the eraser width, drag the Thickness slider.
3. Drag the cursor over the ink or highlighter strokes you want to erase.

To add a line

1. Click the **Line** button, .
2. To change the line type, right-click  and choose a line type from the list.
3. (Optional) To adjust the line width, drag the Thickness slider.
4. (Optional) To change the color, select a color from the Color Palette.
For additional color choices click .
5. (Optional) To adjust the transparency of the line, click the **Transparency** button, , and then choose a transparency percentage.
6. Place the cursor where you want the line to start on the page.
7. Drag the cursor to draw the line.

To add a shape

1. Click the shape button, , , , , or .
- If the desired shape is not visible, right-click the shape button, and choose the shape from the list.
2. (Optional) To adjust the outline width, drag the Thickness slider.
3. (Optional) To change the outline color, select the Outline Color box, and then select a color from the Color Palette.
For additional color choices click .
4. (Optional) To adjust the fill color, select the Fill Color box, and then select a color from the Color Palette.
For additional color choices click .
5. (Optional) To adjust the transparency of the shape, click the **Transparency** button, , and then choose a transparency percentage.
6. Place the cursor where you want the shape to start on the page.
7. Drag the cursor to draw the shape.

To add formatted text

1. Click the **Text** button, .
2. Place the cursor where you want the text to start on the page.
For a fixed width text box, place the cursor where you want the text box to start on the page and then drag to the desired width.
3. Select a font style, size, color, and an alignment option for the text.
4. Enter text in the text box.

Importing a Picture, Multimedia Object, or Document**To import a picture, multimedia object, or document**

1. From MimioStudio Tools, click the **Insert File** button, .
2. From the **Open** dialog box, select the file to import.
3. Click **Open**.

The image or object is displayed on the Notebook page.

-  You can also copy and paste images from another application, or drag images from another application into Notebook.

To insert a screen clipping

1. From MimioStudio Tools, click the **Screen Clipping** button, .
The desktop is displayed with a transparent mask.
2. Drag the cursor to draw a selection box around the area to capture.
The selected area is inserted in the Notebook page.

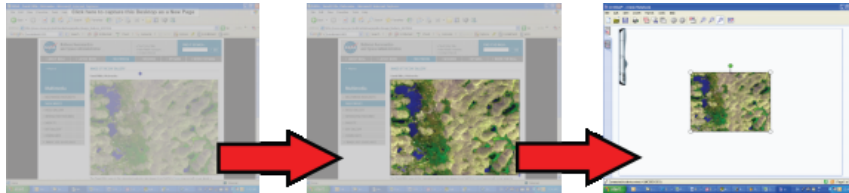

Manipulating Objects

Objects on a page can be moved, rotated, copied, deleted, locked, and have their properties adjusted.

To select an object

1. From MimioStudio Tools, click the **Selection** button, .
2. Do one of the following:
 - Click the object to select.
 - To select multiple objects, press CTRL and select each object.
 - To select multiple objects that are close to each other, drag a selection rectangle over the objects to select.
 - To select all objects on a page, choose **Select All** from the **Edit** menu.

To move an object

1. Select the object to move.
2. Position the cursor over the object.
The cursor changes to the move cursor, .
3. Drag the object to the desired location.

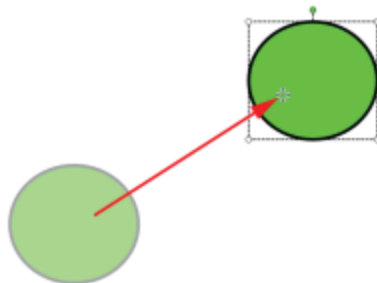

To resize an object

1. Select the object to resize.
A frame is displayed around the object.
2. Position the cursor over one of the white sizing handles.
The cursor changes to the resize cursor, .

3. Drag the cursor to resize the object.

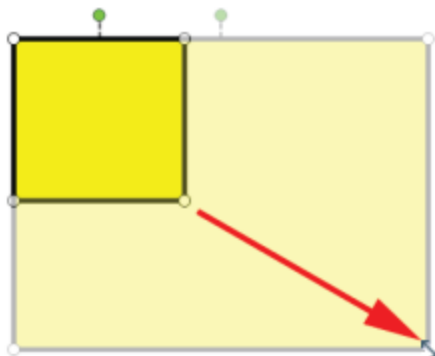

- Press and hold the **SHIFT** key to constrain proportions during resizing.

To rotate an object

1. Select the object to rotate.
A frame is displayed around the object.
2. Position the cursor over the green rotation handle.
The cursor changes to the rotation cursor, .
3. Drag the cursor to rotate the object.
To snap to one of the predefined 45° increments, move the rotate cursor and release over the predefined rotation anchor point.



To lock the position and properties of an object

1. Select the object to lock.
 2. From the **Format** menu, point to **Locking**, and then choose **Lock**.
- A locked object cannot be selected.

To unlock an object





- From the **Format** menu, point to **Locking**, and then choose **Unlock All**.
Objects can only be unlocked collectively; you cannot unlock individual objects.

To delete an object

1. Select the object to delete.
2. Drag the object to the trash can, .

To reorder objects

1. Select the object to reorder.
2. Choose **Order** from the **Format** menu.
3. Choose how to order the object.

Option	Action
 Front	Brings the selected object to the front of the order.
 Back	Sends the selected object to the back of the order.
 Forward	Steps the object forward in the order, by one.
 Backward	Steps the object backward in the order, by one.

To group objects

1. Select the objects to group.
2. From the **Format** menu, point to **Grouping**, and then choose  **Group**.

To ungroup objects

1. Select the objects to ungroup.
2. From the **Format** menu, point to **Grouping**, and then choose  **Ungroup**.

To edit object properties

1. Select the object to edit.
2. To adjust the line width, drag the Thickness slider.
3. To adjust the color, select the Outline Color box or the Fill Color box, and then select a color from the Color Palette.



For additional color choices, click .

4. To adjust the transparency, click the **Transparency** button, , and then choose a transparency percentage.

To edit text



1. Double-click the text box.
2. Select the text to adjust, or enter new text.
3. Adjust the font style, size, color, or alignment.

To import an object from another Notebook page

1. Select the object to import from the source Notebook page.
 2. Click the **Copy** button, .
 3. Navigate to the target Notebook page.
 4. Click the **Paste** button, .
-  You can also import an object by dragging the object from the source page to the target page.

To convert ink to text

1. Select the objects to convert.
All selected objects are combined into one text object.

2. Do one of the following:
 - Right-click, and then choose  **Recognize Ink**.
 - Choose  **Recognize Ink** from the **Tools** menu.

To snap objects to grid

1. Choose  **Grid** from the **View** menu.
The Grid dialog box appears.
2. To force objects to snap to grid, select the **Snap objects to grid** check box.
3. To allow objects to snap to angles, select the **Snap objects to angles** check box.
4. To adjust the spacing between grid snap locations, enter the desired value into the **Spacing** box.
5. To display a grid on the screen, select the **Display grid on screen** check box.
6. To make the grid settings permanent for each new MimioStudio Notebook, select the **Set as default for all new documents** check box.
7. Click **OK**.

Adding Actions to Objects

Objects can have actions associated with them. You can associate an action with any object that you create or import into a MimioStudio Notebook; you cannot add an action to a template or background.

You can choose to perform the associated action each time you click the object or each time you drag the object.

 You can associate two different actions with a single object. For example, you can choose to launch a hyperlink when you click an object and clone the object when you drag the object. However, you cannot associate two different hyperlinks or two different sounds with the same object.

There are three types of actions that you can associate with objects:

- **Launch Hyperlink** - opens a file, a web page, or a different page within a Notebook.
- **Clone** - creates a copy of the object on the Notebook page.
- **Play Sound** - plays a sound file.

To add a hyperlink to an object

1. Select the object to add the hyperlink to.
2. Choose **Hyperlink** from the **Insert** menu.
The Action Settings dialog box appears.
3. Select one of the following from the **Action** list:
 - **On Click** - to launch the hyperlink each time the object is clicked.
 - **On Drag** - to launch the hyperlink each time the object is dragged.
4. Select **Launch Hyperlink** from the **Feature** list.
5. Select **Existing file or Web Page** from the **Link To** list.
Alternately, select a page from within the current Notebook from the **Link To** list.
6. Enter a file name or web address to link to in the **Address** box.

Alternately, click **Browse** to search for a file to link to.

7. Click **OK** to add the hyperlink to the object.

To add cloning to an object

1. Select the object to add the clone action to.
2. Choose **Action Settings** from the **Insert** menu.
The Action Settings dialog box appears.
3. Select one of the following from the **Action** list:
 - **On Click** - to create a copy of the object each time the object is clicked
 - **On Drag** - to create a copy of the object each time the object is dragged
4. Select **Clone** from the **Feature** list, and then click **OK**.

 You can also add the clone action to an object by choosing Clone from the Insert menu. By default, a copy of the object is created whenever you drag the object.

To add a sound to an object

1. Select the object to link the sound file to.
2. Choose **Action Settings** from the **Insert** menu.
The Action Settings dialog box appears.
3. Select one of the following from the **Action** list:
 - **On Click** - to play the sound file each time the object is clicked
 - **On Drag** - to play the sound file each time the object is dragged
4. Select **Play Sound** from the **Feature** list.
5. Click **Load**.
The Open dialog box appears.
6. Navigate to and select the sound file to link to the object, and then click **Open**.
7. Click **OK** in the **Action Settings** dialog box.

To remove an action from an object

1. Select the object with the action to remove.
2. Choose **Action Settings** from the **Insert** menu.
The Action Settings dialog box appears.
3. Choose **None** from the **Feature** list, and then click **OK**.

Using MimioStudio Gallery

MimioStudio Gallery consists of the following four main folders:

- **Screen Annotations** - contains all saved Screen Annotation snapshots.
- **Imported Content Packs** - contains any imported content that you have not yet added to the Gallery folder.
- **Questions and Results** - contains a variety of objects for use with MimioVote.
- **Gallery** - contains a number of different folders used to categorize items, such as Geography, Mathematics, and so on.

The Gallery folder and subfolders can contain five different types of objects:

- **Images** - Images include pictures and graphics.
 - **Templates** - Templates include backgrounds and predefined page layouts.
 - **Multimedia** - Multimedia objects include movies, animation, and sound.
 - **Questions and Results** - Questions and Results include objects for creating and displaying the results of MimioVote activities.
-  This section of the Gallery does not appear until you move objects from the Questions and Results folder to the Gallery folder or a Gallery subfolder.
- **Lessons** - Lessons include lessons created using MimioStudio Notebook and imported documents. You can create your own lessons or import lessons created by someone else.

See Accessing MimioStudio Gallery for information on accessing MimioStudio Gallery.

To navigate MimioStudio Gallery

- ▶ Click any folder to view the available items in that folder.
- ▶ Click the plus sign next to a Gallery folder to see any subfolders that are contained in that Gallery folder.

To select a Gallery item

1. Navigate to the Gallery folder that contains the item you want to select.
2. Do one of the following:
 - Click the Gallery item to select.
 - To select multiple items, press CTRL and select each item.
 - To select multiple items that are close to each other, drag a selection rectangle over the items to select.
 - To select a range of items, select the first item, and then press SHIFT and select the last item.
 - To select all items, right-click, and then choose **Select All**.

Importing Gallery Items into a Notebook

You can import any Gallery item into a MimioStudio Notebook to add to your presentation.

To import a Gallery item into a Notebook

1. Select the image, template, multimedia item, questions and results object, or lesson to import.
2. Drag the item into the Notebook.

 You can also import items by double-clicking or by copying and pasting the items into a Notebook.

Customizing the Content of the Gallery

The MimioStudio Gallery is fully expandable and modifiable, so you can add your own folders, pictures, templates, multimedia items, and lessons.

You can also add Microsoft Word, Excel, PowerPoint, and PDF documents to the Gallery. All imported documents are placed in the Lessons section of the MimioStudio Gallery

 MimioStudio does not support network or shared galleries.

To import a Gallery folder from a Gallery file

1. Click the **Import Content Pack** button, .
 2. From the **Open** dialog box, navigate to and select the Gallery file to import.
 3. Click **Open**.
- The contents of the Gallery file are added to the Imported Content Packs folder in MimioStudio Gallery.
4. Review the imported content and make any desired changes.
 5. To move the content to the Gallery folder, right-click the folder to move and then choose **Install**.

The content is moved to the Gallery folder.

To add a new Gallery folder

1. Select the main Gallery folder or a Gallery subfolder to add the new folder to.
2. Click the **New Folder** button, .
- The Gallery Item Properties dialog box appears.
3. Enter a name for the new folder in the **Name** box.
4. (Optional) Enter a keyword in the **Keywords** box to make the new folder searchable from the Gallery search bar.
5. Click **OK**.

To add a new item to a folder

1. Select the folder to add the item to.
2. Click the **Insert File** button, .
3. From the **Open** dialog box, navigate to and select the file to import.
4. Click **Open**.



The item is inserted in the appropriate area of the Gallery folder.

 You can also add new items by selecting one or more items, and then dragging and dropping or copying and pasting them into a Gallery folder.

To create a template from a Notebook image

1. Right-click and drag the image into the Gallery.
The right-click menu appears.
2. Choose **Insert as template**.

To copy an existing Gallery item

1. Select the Gallery item to copy.
2. Click the **Copy** button, .
3. Select a Gallery folder to insert the new item into.
4. Click the **Paste** button, .

The item is inserted in the appropriate area of the Gallery folder.

To delete a Gallery item

1. Select the Gallery item to delete.
2. Click the **Delete** button, .
- A delete confirmation dialog box appears.
3. Click **Yes**.

To find similar Gallery items

1. Right-click the Gallery item, and then choose **Open Folder**.
2. If the item is contained in more than one folder, choose the folder to open.
The folder containing the selected item opens in MimioStudio Gallery.

Exporting a Gallery Folder to a Gallery File

Entire Gallery folders can be exported and imported into the MimioStudio Gallery as Gallery (MCF) files. You can then share Galleries that you have created with other MimioStudio users.

 MimioStudio does not support network or shared galleries.

To export a Gallery folder to a Gallery file

1. Select the Gallery folder to export.
2. Click the **Export Content Pack** button, .
3. From the **Save As** dialog box, enter a name for the file in the **File Name** box.
4. Select a location to save the file to.
5. Click **Save**.

Working with Saved Annotation Snapshots

MimioStudio automatically saves a snapshot of the annotated screen each time you exit Screen Annotation mode. These snapshots are saved in the Screen Annotations folder in MimioStudio Gallery.

For information about creating Screen Annotation snapshots, see Marking Up the Display Using Screen Annotations.

Viewing Screen Annotation Snapshots

You can view your saved screen annotations from the Screen Annotations folder in MimioStudio Gallery.

To view Screen Annotation snapshots

1. Start MimioStudio Gallery.
2. Select the **Screen Annotations** folder.

To select a snapshot

- ▶ Do one of the following:
 - Click on the snapshot to select.
 - To select multiple snapshots, press CTRL and select each snapshot.
 - To select multiple snapshots that are close to each other, drag a selection rectangle over the snapshots.
 - To select a range of snapshots, select the first snapshot and then press **SHIFT** and select the last snapshot.
 - To select all snapshots, right-click, and then choose **Select All**.

Renaming an Annotation Snapshot

Screen Annotation snapshots are saved in chronological order, using the date and time that the snapshot was created as the name of the snapshot. You can rename a snapshot any time after it has been saved.

To rename a snapshot

1. Select the snapshot to rename.
2. Right-click and choose **Properties**.
3. Enter a name for the snapshot in the **Name** box and click **OK**.

Adding Keywords to an Annotation Snapshot

You can add keywords to any snapshot so that you can use the search bar in MimioStudio Gallery to find that snapshot later.

To add keywords to a snapshot

1. Select the snapshot to add keywords to.
2. Right-click and choose **Properties**.
3. Enter each keyword on a separate line in the **Keywords** box and click **OK**.

Searching for an Annotation Snapshot

You can search for a specific snapshot using the search bar in MimioStudio Gallery. You can search for a snapshot using a keyword or part of the snapshot name.

To search for a specific snapshot

1. Select the **Screen Annotations** folder in the Gallery.
2. Enter text to search for in the **Search** box.

All snapshots associated with the text appear in the preview area of the Gallery.

Importing an Annotation Snapshot

You can import a snapshot into an open Notebook.

To import a snapshot

1. Open a MimioStudio Notebook.
2. Select the snapshot to import.
3. Drag the selected snapshot into the target Notebook.

Pasting an Annotation Snapshot Into Another Application

Annotation snapshots can be used in other applications such as Microsoft Word or PowerPoint.

To paste a snapshot into another application

1. Select the snapshot to copy.
2. Click the **Copy** button, .
3. Navigate to the target application.
4. Right-click, and then choose **Paste**.

Alternatively, you can drag the selected snapshot into the target application.

Printing Annotation Snapshots

You can print a snapshot directly from the Screen Annotations folder in MimioStudio Gallery.

To print a snapshot

1. Select the snapshot to print.
2. Right-click and choose **Print**.

Deleting Annotation Snapshots

You can delete snapshots from the Screen Annotations folder.

To delete a snapshot

1. Select the snapshot to delete.
2. Click the **Delete** button, .
- A delete confirmation dialog box appears.
3. Click **Yes**.

Delivering Interactive Notebook Lessons and Presentations

MimioStudio Notebook can be used to deliver lessons and presentations that were created in or imported into a MimioStudio Notebook.

Using Fullscreen View

For presenting information, the Fullscreen view can be used to fill the entire screen with the current page.

The MimioStudio Notebook standard toolbar and all MimioStudio Tools are available in Fullscreen view.





To access the Fullscreen view

- ▶ Click the **Fullscreen** button, .
- The current page fills the entire screen and the MimioStudio Notebook standard toolbar remains visible.

Navigating Through a Presentation

To navigate through a Notebook presentation

- ▶ Use the MimioStudio Notebook standard toolbar to navigate through the Notebook presentation.

Button	Action
	Use this button to enter or exit the Fullscreen view.
	Use this button to insert a new page
	Use this button to return to the previous page in the Notebook.
	Use this button to advance to the next page in the Notebook.

Working with Multimedia Objects

You can play, pause, fast forward, and rewind movie, animation, and sound objects you added to your presentation.

To play video or audio

- ▶ Click anywhere on the movie, animation, or sound object to play.

To show and hide the video and audio controls

1. While the video or audio is playing, click once anywhere on the object to view the object controls.



2. Click the object again to hide the controls.

To pause, fast forward, or rewind video or audio

- ▶ Do one of the following:
 - To pause the video or audio, click .
 - To fast forward the video or audio, drag the slider to the right.
 - To rewind the video or audio, drag the slider to the left.

Chapter 3

MimioTeach

Using MimioTeach with a projector, you can deliver lessons and presentations directly from your whiteboard. Using MimioStudio Interactive mode, you control the movement of the cursor on your screen with the MimioTeach stylus, much like you would with a mouse at your computer.

What's Included

The MimioTeach package contains the following items:

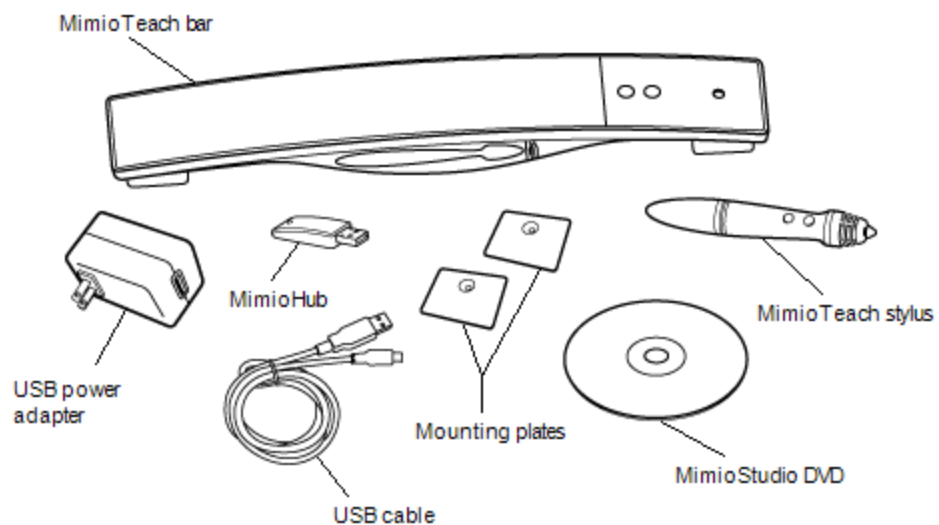

If you are missing any of the items above, contact Customer Support.

About MimioTeach

You can use the MimioTeach bar and stylus in MimioStudio Interactive mode to deliver lessons and presentations.

You can also use the MimioTeach bar with MimioCapture to capture notes from your whiteboard into MimioStudio Notebook. For more information about using MimioTeach with MimioCapture, see MimioCapture.

The following figure shows the major components of the MimioTeach.

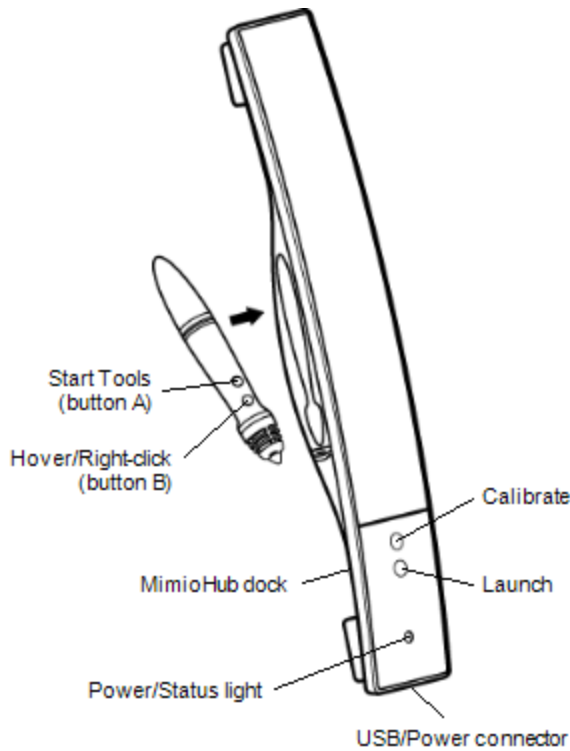

Status Lights

The status light visually shows the status of the MimioTeach bar.

Off	Not receiving power; USB/power cable is not connected or MimioTeach is turned off.
Solid Green	MimioTeach is connected and receiving power; MimioStudio software is running.
Flashing Green	MimioTeach is connected or connecting, and receiving power; MimioStudio software is not running.
Solid Amber	MimioTeach cannot find an available MimioHub.
Flashing Amber	MimioTeach is searching for an available MimioHub.

About MimioStudio Tools

With the various presentation tools found in MimioStudio Tools you can focus your audience on a specific area of the screen by displaying only certain parts of the screen. You can also annotate the screen with the drawing tools available in MimioStudio Tools using the Screen Annotation feature.

For more information about MimioStudio Tools, see [Marking Up the Display Using Screen Annotations](#).

The following figure shows the major components of MimioStudio Tools.

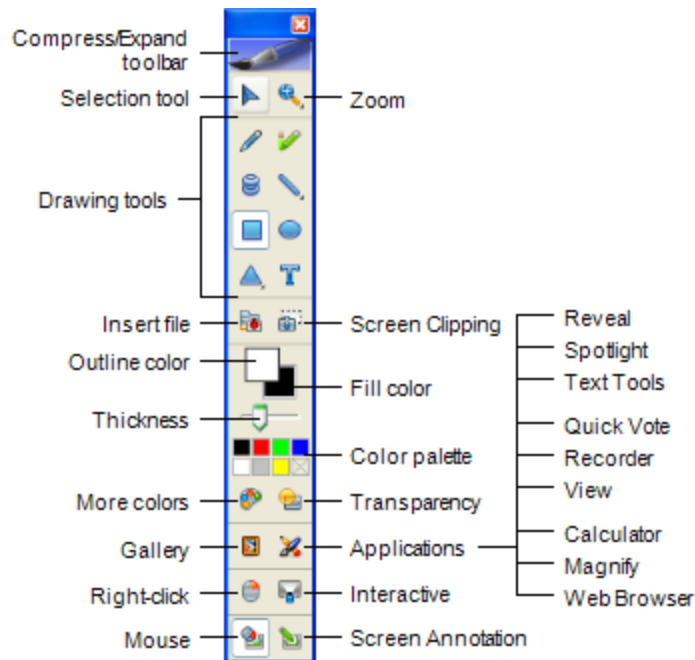

Getting Started

Review the following topics to install and start using your MimioTeach.

- Setting Up the MimioTeach Stylus
- Setting Up the MimioTeach Bar
- Setting Up Interactive Mode

Setting Up the MimioTeach Stylus

The MimioTeach stylus is powered by a rechargeable lithium-ion battery. The battery recharges whenever the stylus is docked on the MimioTeach bar.

To set up the MimioTeach stylus

1. Turn the top of the stylus counter-clockwise to separate the top from the body of the stylus.



2. Remove the plastic strip from the stylus.

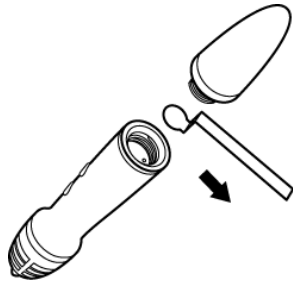

3. Replace the top onto the body of the stylus and turn clockwise to attach.

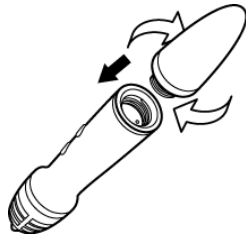

Setting Up the MimioTeach Bar

The MimioTeach bar comes pre-linked to the included MimioHub. You can also use this MimioHub to connect other MimioClassroom devices to your computer, such as MimioVote.

- 💡 When not in use, the MimioHub can be stored in the MimioHub dock on the back of the MimioTeach bar.

MimioTeach is powered using the included USB cable and power adapter.

- 📄 Optionally, MimioTeach can be powered using three AAA batteries. For information about using batteries to power the MimioTeach bar, see Inserting the Batteries.

To set up the MimioTeach bar

1. Plug the USB cable into the USB port on the power adapter.

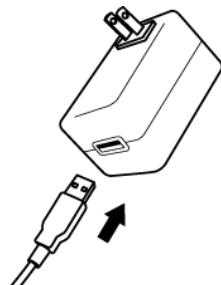

2. Plug the other end of the USB cable into the USB port on the MimioTeach bar.

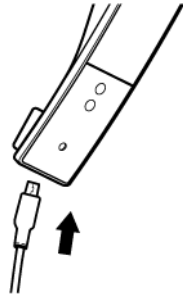

3. Plug the power adapter into a power outlet.

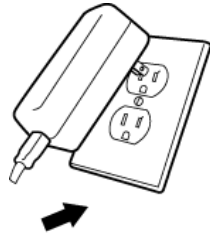

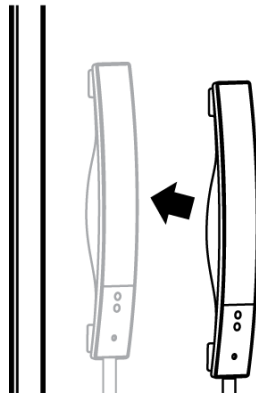

4. Place the MimioTeach bar along the left edge of the whiteboard as shown.

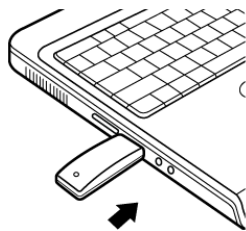

The MimioTeach bar attaches securely to any magnetic whiteboard. See [Mounting MimioTeach to a Non-Magnetic Whiteboard](#) for information about mounting the bar to a non-magnetic whiteboard.

5. Plug the MimioHub into an available USB port on your computer.



 If you do not want to connect the MimioTeach bar to your computer wirelessly, you can link the bar to your computer using the included USB cable without the power adapter. The bar will be powered by USB through your computer.

Setting Up Interactive Mode

Using MimioStudio Interactive mode, you can deliver lessons and presentations directly from your whiteboard.

To use Interactive mode you need a projector, a MimioTeach-enabled whiteboard, and a MimioTeach stylus. Combined, these devices make for a powerful tool for delivering lessons and presentations.

Projecting Your Desktop

If you are presenting from a MimioStudio Notebook or another application, such as a PowerPoint presentation, you can open the application before or after Interactive mode is enabled and calibrated.

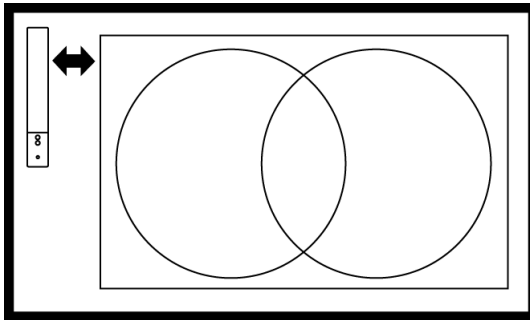

To set up for Interactive mode

1. Project your desktop image onto your whiteboard.
Refer to your projector's documentation for instructions on how to project your desktop image.
2. Adjust the projected image to have a 2-inch to 3-inch buffer between the edge of your projection and your MimioTeach.



3. Click the MimioTeach stylus anywhere on the whiteboard.
Interactive mode starts and the calibration screen appears.

To exit Interactive mode



- ▶ Do one of the following:
 - Press the **Interactive** button, , on the MimioTeach bar.
 - Start MimioStudio Tools, click **Interactive** , and then click **Exit**.
 - Start MimioStudio Settings, select **Interactive**, and then click **Disable**.
See Customizing MimioStudio for information on how to access MimioStudio Settings.

Calibrating Interactive Mode

Each time Interactive mode is enabled, you are prompted to calibrate using the MimioTeach stylus.

When using a permanently installed whiteboard and projector, you do not need to recalibrate Interactive mode after the first session. See Adjusting the Interactive Settings.

To calibrate Interactive mode

1. If the calibration screen does not appear when you start Interactive mode, do one of the following:
 - Start MimioStudio Tools, click the **Interactive** button, , and then click **Recalibrate**.
 - Press the **Interactive** button, , on your MimioTeach bar.
 - Start MimioStudio Settings, select **Interactive**, and then click **Calibrate**.
2. Press the MimioTeach stylus down on the whiteboard at the center of each of the nine calibration targets.

Make sure to hold the stylus perpendicular to the writing surface as you click.

The calibration target disappears and the next calibration target appears.

When the calibration screen disappears, Interactive mode is enabled.

Using MimioTeach

You can use the MimioTeach bar and stylus in MimioStudio Interactive mode to deliver lessons and presentations. In MimioStudio Interactive mode, you control the movement of the cursor on your screen with the MimioTeach stylus, much like you would with a mouse at your computer.

You can also use the various presentation tools found in MimioStudio Tools to focus your audience on a specific area of the screen by displaying only certain parts of the screen. And, you can annotate the screen with the drawing tools available in MimioStudio Tools using the Screen Annotation feature.

Using the MimioTeach Stylus

In Interactive mode, the MimioTeach stylus can be used to control your desktop and interact with applications on your computer from your whiteboard.

The following table describes how to use the MimioTeach stylus to control your desktop from the whiteboard.

To execute	Do this
Left mouse click	Click in the projected area at the desired location with the tip of the stylus.
Double left mouse click	Quickly click twice in the projected area at the desired location with the tip of the stylus.
Right mouse click	Press the B button on the stylus, and then click in the projected area at the desired location with the tip of the stylus.
Hover	<ol style="list-style-type: none"> 1. Hold the stylus at the desired location, staying as close to the whiteboard as possible without touching it. 2. Press the B button on the stylus. 3. Move the stylus to the desired location. 4. Release the B button on the stylus.

To change the functions of the MimioTeach stylus buttons, see [Adjusting the Interactive](#)

Focusing Attention Using the Reveal and Spotlight Tools



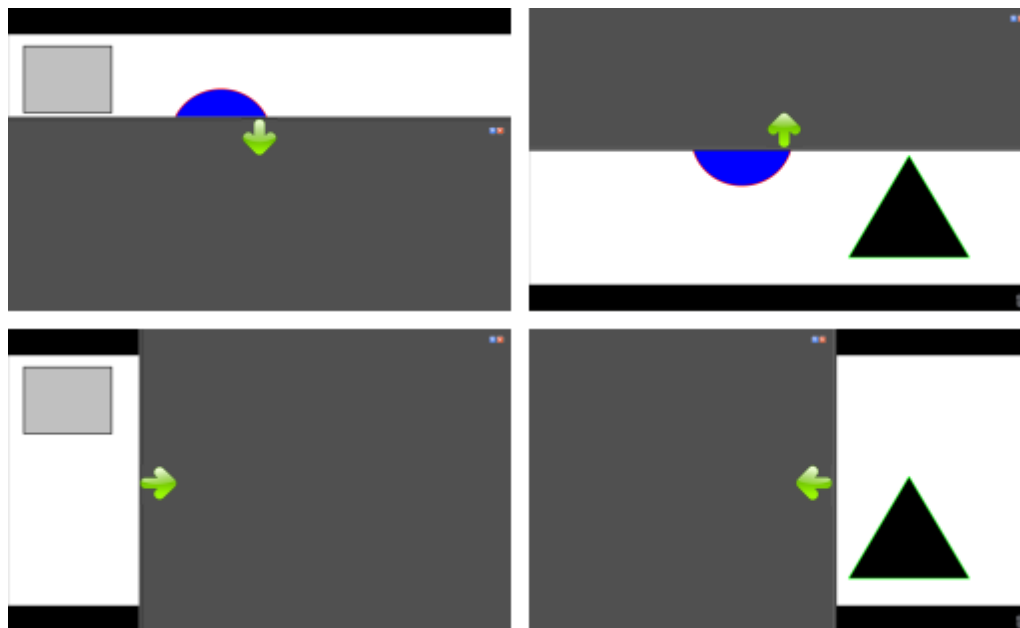

The Reveal tool and the Spotlight tool help you to focus your audience on a specific area of the screen by keeping parts of the screen hidden.

Using the Reveal Tool

The Reveal tool creates a *shade* that you can raise, lower, move left, and move right over the screen image, as if you are moving a shade up, down, or across the screen. You can then expose bullet points or other information progressively.



To use the Reveal tool

- ▶ Do one of the following:
 - From MimioStudio Tools, click the **Applications** button, , and then choose  **Reveal**.
 - (*Interactive mode only*) Press the **Launch** button, , on the MimioTeach bar, and then click  **Reveal** in the Launch window.

To adjust the revealed area

- ▶ Click inside the shaded area and drag down, up, left, or right to reveal more or less of the displayed area.

To adjust the transparency of the Reveal tool

1. Click , and then point to **Transparent**.
2. From the **Transparent** list, choose a percentage.

A transparency of 0% means that the shaded area will be completely opaque.





Using the Spotlight Tool

The Spotlight tool masks the entire screen except for a small area, the spotlight. You can then focus audience attention on a specific area of the screen. The spotlight area can be

reshaped, resized, and moved around the screen.





To use the Spotlight tool

1. Do one of the following:
 - From MimioStudio Tools, click the **Applications** button, , and then choose  **Spotlight**.
 - *(Interactive mode only)* Press the **Launch** button, , on the MimioTeach bar, and then click  **Spotlight** in the Launch window.
2. Click the shaded area outside of the spotlight border and drag the spotlight to the desired location.

To adjust the shape of the spotlight

1. Click , and then point to **Shape**.
2. From the **Shape** list, choose a shape for the spotlight.

To resize the spotlight

1. Click , and then point to **Size**.
 2. From the **Size** list, choose a spotlight size.
-  You can also resize the spotlight by dragging the colored border of the spotlight until the spotlight is the desired size.

To adjust the spotlight transparency

1. Click , and then point to **Transparent**.
2. From the **Transparent** list, choose a transparency percentage.
A transparency of 0% means that the shaded area will be completely opaque.



Marking Up the Display Using Screen Annotations

Screen Annotation mode allows you to annotate applications, web pages, and images. When in Annotation mode, a green border with a faded edge appears around your desktop.

When you exit from Screen Annotation mode, all annotations are cleared from the whiteboard and automatically archived in the Screen Annotations folder in MimioStudio Gallery.



Enabling Screen Annotation Mode

To enable Screen Annotation mode



1. Do one of the following
 - From MimioStudio Tools, click the **Screen Annotation** button, , to freeze your current desktop image.
 - *(Interactive mode Only)* Press the **Launch** button, , on the MimioTeach bar, and then click  **Screen Annotation** in the Launch window.A green border with a faded edge appears around your desktop.
2. Annotate the screen using MimioStudio Tools.

All object, drawing, and manipulation features in MimioStudio Tools are available in Screen Annotation mode.

To exit Screen Annotation mode

- ▶ Do one of the following:
 - From MimioStudio Tools, click the **Mouse** button, , to “unfreeze” the screen.
 - *(Interactive mode only)* Press the **Launch** button, , on the MimioTeach bar, and then click  **Screen Annotation** in the Launch window.

To disable the Annotation mode border

1. Right-click  in the notification area of the taskbar and choose  **Settings**.
2. Select  **Notebook** from the **MimioStudio Settings** dialog box.
3. Under **General**, clear the **Enable fullscreen border (Screen Annotation only)** check box.
4. Click **OK** to save the settings.

Annotating the Screen Using MimioStudio Tools

MimioStudio Tools are used to annotate the screen. All object, drawing, and manipulation features in MimioStudio Tools are available in Screen Annotation mode.



Once you select a drawing tool, that tool remains selected until you select a different drawing tool or the selection tool.

See *Manipulating Objects* for a complete description of manipulating objects.

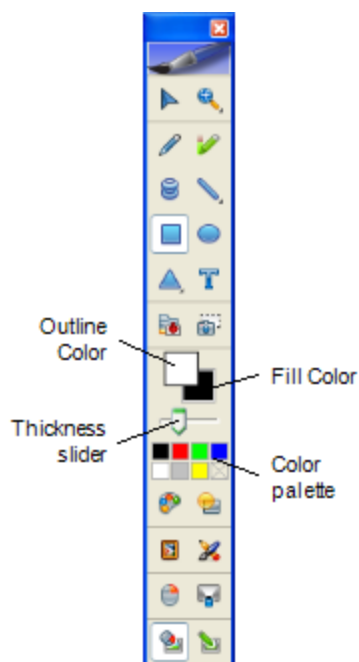

All of the functions and features of the MimioStudio drawing tools that are available in MimioStudio Notebook are available in Screen Annotation mode.



To use the freehand pen

1. Click the **Pen** button, .
2. (Optional) To adjust the line width, drag the Thickness slider.
3. (Optional) To adjust the line color, select a color from the Color Palette.
For additional color choices click .
4. (Optional) To adjust the transparency of the line, click the **Transparency** button, , and then choose a transparency percentage.
5. Place the cursor where you want the ink stroke to start on the page.
6. Drag the cursor to draw ink strokes.



To highlight a portion of the display



1. Click the **Highlighter** button, .
2. (Optional) To adjust the highlighter width, drag the Thickness slider.
3. (Optional) To change the color, select a color from the Color Palette.
For additional color choices click .
4. Place the cursor where you want the highlight stroke to start on the page.
5. Drag the cursor over the area you want to highlight.

To erase ink and highlighting









1. Click the **Eraser** button, .
2. (Optional) To adjust the eraser width, drag the Thickness slider.
3. Drag the cursor over the ink or highlighter strokes you want to erase.

To add a line

1. Click the **Line** button, .
2. To change the line type, right-click  and choose a line type from the list.
3. (Optional) To adjust the line width, drag the Thickness slider.

4. (Optional) To change the color, select a color from the Color Palette.
For additional color choices click .
5. (Optional) To adjust the transparency of the line, click the **Transparency** button, , and then choose a transparency percentage.
6. Place the cursor where you want the line to start on the page.
7. Drag the cursor to draw the line.

To add a shape

1. Click the shape button, , , , , or .
- If the desired shape is not visible, right-click the shape button, and choose the shape from the list.
2. (Optional) To adjust the outline width, drag the Thickness slider.
3. (Optional) To change the outline color, select the Outline Color box, and then select a color from the Color Palette.
For additional color choices click .
4. (Optional) To adjust the fill color, select the Fill Color box, and then select a color from the Color Palette.
For additional color choices click .
5. (Optional) To adjust the transparency of the shape, click the **Transparency** button, , and then choose a transparency percentage.
6. Place the cursor where you want the shape to start on the page.
7. Drag the cursor to draw the shape.

To add formatted text

1. Click the **Text** button, .
2. Place the cursor where you want the text to start on the page.
For a fixed width text box, place the cursor where you want the text box to start on the page and then drag to the desired width.
3. Select a font style, size, color, and an alignment option for the text.
4. Enter text in the text box.

Clearing All Annotations from the Display

When you exit Screen Annotation mode, all annotations are cleared from the display and all annotations are automatically preserved as a snapshot of the display. See *Working with Saved Annotation Snapshots* for information about reviewing and using the snapshots.

Inserting Text Into an Application Using MimioStudio Text Tools

You can enter text into any text-entry box or page using the MimioStudio Text Tools. The Text Tool has three modes for entering text:









- On-Screen Keyboard allows you to enter text through an on-screen keyboard application.
- Write Anywhere allows you to enter text by writing anywhere on the screen. Your handwriting is automatically converted into text and entered into the current application.

 Write Anywhere is only available on Windows XP 32-bit.





- Writing Pad allows you to enter text through a small on-screen writing pad. Your handwriting is automatically converted into text and input into the current application.

In addition, Write Anywhere and Writing Pad also support gesture recognition, which allows handwritten shortcuts to be automatically recognized as commonly used keys.

To access MimioStudio Text Tools

1. From MimioStudio Tools, click the **Applications** button, , and then choose  **Text Tools**.
2. Right-click the **Text Tools** icon , , or  in the notification area of the Windows taskbar.
3. Choose the Text Tool that you want to use.
 -  **Keyboard** to enable the On-Screen Keyboard.
 -  **Write Anywhere** to enable Write Anywhere.
 -  **Writing Pad** to enable Writing Pad.

To disable MimioStudio Text Tools

- ▶ Do one of the following:
 - Click the **Text Tools** icon , , or  in the notification area of the taskbar.
 - From MimioStudio Tools, click the **Applications** button, , and then choose  **Text Tools**.

Using the On-Screen Keyboard

You can enter text into any application using the On-Screen Keyboard.

To use the On-Screen Keyboard

1. Start the On-Screen Keyboard.
2. Click in the text-entry box or on the page where you want to enter the text.
3. Using your mouse or MimioTeach stylus, press the virtual keys on the on-screen keyboard.

The text is entered into the text-entry box or on the page that you selected.

Using Write Anywhere

With Write Anywhere you can enter text into any text-entry box or page, by writing anywhere on the screen with the MimioTeach stylus while in Interactive mode. You can also use Write Anywhere with your mouse or other input device from your computer.

 Write Anywhere is only available on Windows XP 32-bit.





To use Write Anywhere

1. Start Write Anywhere.

The Write Anywhere on-screen buttons appear.
2. Click in the text-entry box or on the page where you want to enter the text.
3. Using your mouse or MimioTeach stylus, write anywhere on the screen.

Your handwriting is automatically converted to text and entered into the text-entry box

4. Use the on-screen buttons for commonly used keys.

Button	Description
	Backspace
	Enter
	Tab
	Space





Write Anywhere also supports gesture recognition for commonly used keys. See [Using Gesture Recognition](#).

Using Writing Pad

With Writing Pad you can enter text through a small on-screen writing pad using the MimioTeach stylus while in Interactive mode. You can also use Writing Pad with your mouse or other input device from your computer.

To use Writing Pad

1. Start Writing Pad.
The on-screen writing pad appears.
2. Click in the text-entry box or on the page where you want to enter the text.
3. Using your mouse or MimioTeach stylus, write within the yellow space of the on-screen writing pad.
Your handwriting is automatically converted to text and entered into the text-entry box or on the page that you selected.
4. Use the on-screen buttons for commonly used keys.



Button	Description
	Backspace
	Enter
	Tab
	Space

Writing Pad also supports gesture recognition for commonly used keys. See [Using Gesture Recognition](#).

Using Gesture Recognition

With gesture recognition, handwritten shortcuts are automatically recognized as commonly used keys. Both Write Anywhere and Writing Pad support gesture recognition.

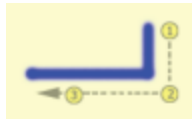
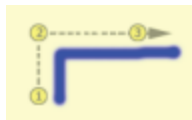



The following table describes how to use gestures to perform common functions.

To press	Do this	
Backspace	Draw a line from right to left.	
Enter	Draw a connected line from top to bottom and then from right to left.	
Tab	Draw a connected line from bottom to top and then from left to right.	
Space bar	Draw a connected line from bottom to top and then from right to left.	

Using the Web Browser, Calculator, and Magnify Tools

MimioStudio Tools includes shortcuts for accessing a Web browser, a calculator, and a magnifier.

To use the tools

1. Start MimioStudio Tools.
2. Click the **Applications** button, , choose **More Tools**, and then choose one of the following tools:
 -  Calculator
 -  Magnify
 -  Web Browser

Recording Desktop Actions and Audio in Interactive Mode

Using MimioStudio Recorder, you can record your interactions into an AVI movie file, with or without audio. See Using MimioStudio Recorder for more information on how to use MimioStudio Recorder.

Caring for MimioTeach

Review the following topics for information about cleaning, inserting the batteries, and permanently mounting your MimioTeach.

- Cleaning MimioTeach
- Inserting the Batteries
- Mounting MimioTeach to a Non-Magnetic Whiteboard

Cleaning MimioTeach

MimioTeach is designed to give you long and trouble-free service while requiring very little maintenance.

You can easily clean your MimioTeach using the following items:

- Lint-free cloth.
- Isopropyl alcohol, diluted dishwashing detergent, or diluted glass cleaner.
- ⚠ If you use glass cleaner, make sure it does not contain ammonia.

To clean the MimioTeach bar and stylus

1. Disconnect the USB cable from the MimioTeach bar.
2. Use the lint-free cloth to wipe the exterior of the MimioTeach bar and stylus.
3. Remove dirt and smudges with one of the cleaning solutions mentioned above.
 - ⚠ Avoid using liquids on any exposed charging contacts. Do not allow liquid into any openings on the equipment.
4. Reconnect the USB cable.

Inserting the Batteries

MimioTeach is powered using the included USB cable and power adapter. Optionally, MimioTeach can be powered using three AAA batteries.

To insert the batteries

1. Press down and slide off the battery compartment cover.
 2. Insert three AAA batteries into the battery compartment.
 3. Replace the battery compartment cover.
- 📌 Remove the batteries if the MimioTeach bar will not be used for a long period of time.

Mounting MimioTeach to a Non-Magnetic Whiteboard

The MimioTeach bar attaches securely to any magnetic whiteboard. If you do not have a magnetic whiteboard, you can mount the MimioTeach bar to your whiteboard using the included metal plates.

- 📌 If you are installing both MimioTeach and MimioCapture, you must mount MimioCapture before mounting MimioTeach. This will ensure proper placement of the MimioTeach bar. See Mounting MimioCapture to a Non-Magnetic Whiteboard for information on mounting MimioCapture.

To mount MimioTeach to a non-magnetic whiteboard

1. Place the metal plates against the back of the MimioTeach bar as shown.
Make sure that the recess on each plate is inserted into the recess on the back of the MimioTeach bar.

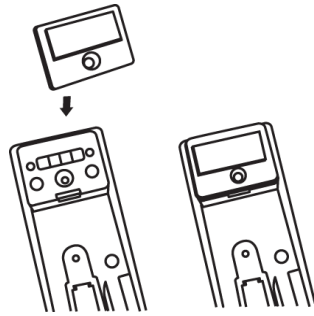

2. Remove the paper backing from the adhesive strips to expose the adhesive.

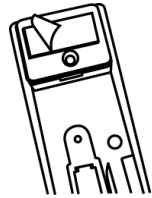

3. Press the MimioTeach bar firmly along the left edge of the whiteboard as shown.

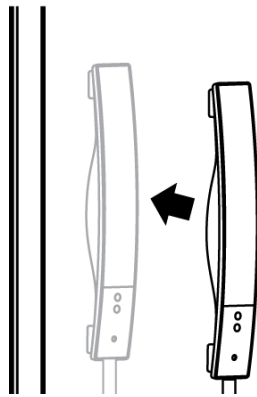

This page intentionally left blank for double-sided printing.

Chapter 4

MimioCapture

MimioCapture is used with a MimioTeach-enabled whiteboard to record notes and drawings from your whiteboard. Using MimioStudio Ink Capture mode, you make notes and drawings on your whiteboard using the MimioCapture pens. Your notes are automatically captured in a MimioStudio Notebook.

What's Included

The MimioCapture package contains the following items:

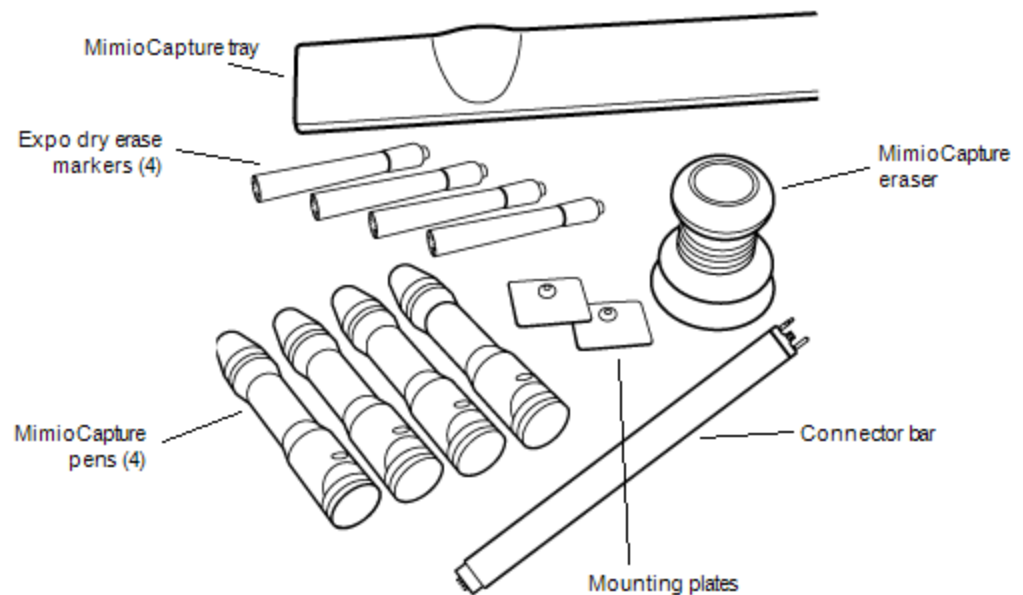

If you are missing any of the items above, contact Customer Support.

About MimioCapture

MimioCapture includes four pens and one eraser for making notes on your MimioTeach-enabled whiteboard. The MimioCapture tray is used to store and charge the pens and eraser. You can also perform some common actions using the buttons on the MimioCapture tray.

The following figure shows the major components of MimioCapture.

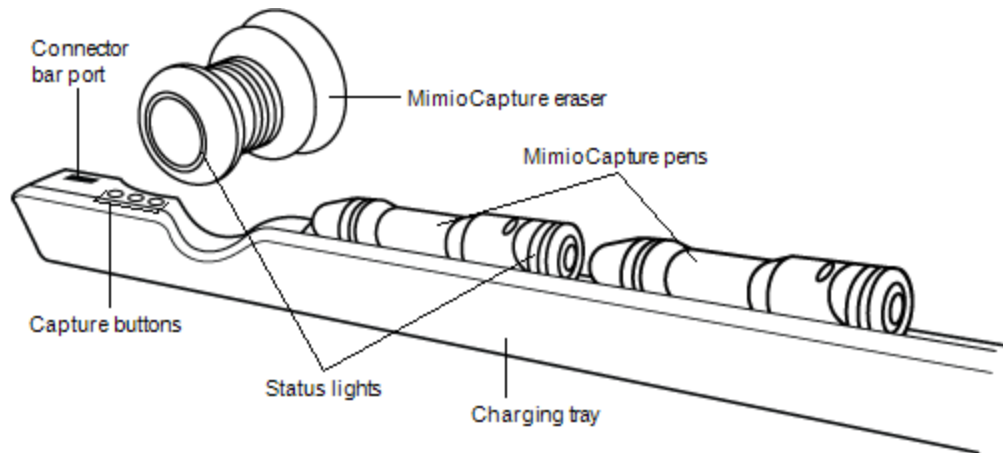

Status Lights

The status lights visually show the status of each MimioCapture pen and the MimioCapture eraser.

Off	The MimioCapture pen or eraser is not receiving power. The status light is off when the pen or eraser is in use.
Amber	The MimioCapture pen or eraser has a low battery. The battery should be recharged.
Solid Green	The MimioCapture pen or eraser is charging.

About MimioStudio Notebook

As you make notes on your whiteboard using MimioCapture, you can automatically save those notes into MimioStudio Notebook. Once the information is in Notebook, you can save the Notebook as a MimioStudio INK file or a variety of other formats.

For more information about using MimioStudio Notebook, see [Working with MimioStudio Notebook](#).

The following figure shows the major components of MimioStudio Notebook.

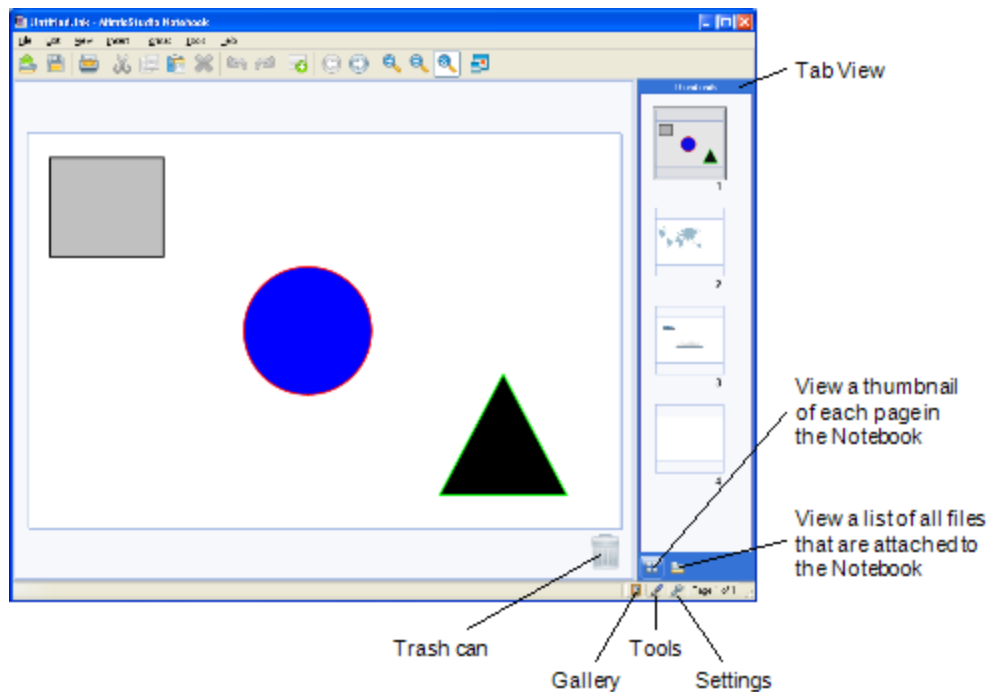

Getting Started

MimioCapture links directly to your MimioTeach for seamless integration with MimioStudio software. Before you can begin capturing digital ink, you must first set up your MimioCapture tray, MimioCapture pens, MimioCapture eraser, and MimioStudio Notebook.

Setting Up the MimioCapture Tray

The MimioCapture tray is powered using the USB cable and power adapter that were included with your MimioTeach. The MimioTeach bar connects to the MimioCapture tray using the connector bar that was included with your MimioCapture.

To connect

1. Remove the MimioTeach bar from the whiteboard.
2. Unplug the USB cable from the MimioTeach bar.

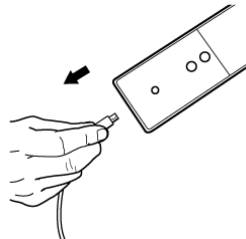

3. Plug the USB cable into the USB port on the MimioCapture tray.

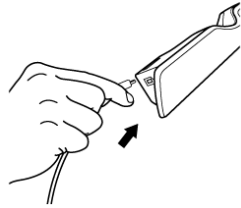

4. Place the MimioCapture tray along the bottom-left edge of the whiteboard as shown.

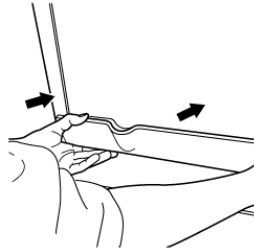

The MimioCapture tray attaches securely to any magnetic whiteboard. See [Mounting MimioCapture to a Non-Magnetic Whiteboard](#) for information about mounting the tray to a non-magnetic whiteboard.

5. Connect the connector bar to the MimioCapture tray as shown.

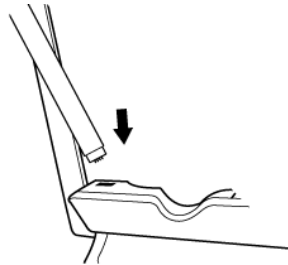

6. Connect the other end of the connector bar to the MimioTeach bar as shown.

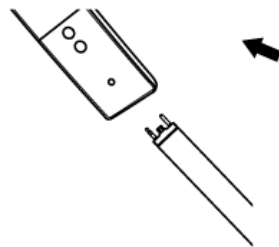

7. Reattach the MimioTeach bar along the left side of the whiteboard.

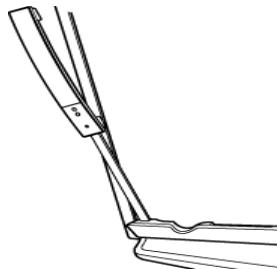

Setting Up the MimioCapture Pens

MimioCapture comes with four colored MimioCapture pens and four Expo® dry erase markers. Before you can start using MimioCapture, you must first set up your MimioCapture Pens.

The MimioCapture pens are each powered by a rechargeable lithium-ion battery. The pens charge whenever they are docked on the MimioCapture tray.

To set up the MimioCapture pens

1. Pull the plastic strip from the top part of the pen to activate the rechargeable battery.

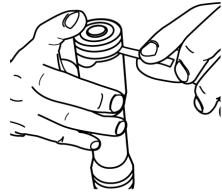

2. Press the button on the side of the pen and pull the top part of the pen from the pen body.

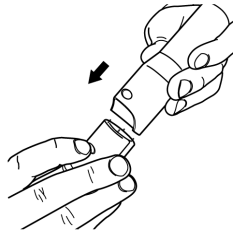

3. Insert a colored Expo® dry erase marker into the matching colored pen body.

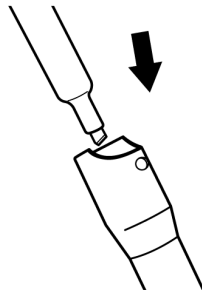

4. Replace the top part of the pen onto the pen body.

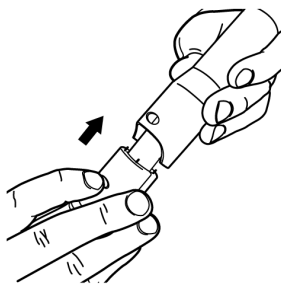

5. Place the pen cap onto the pen.

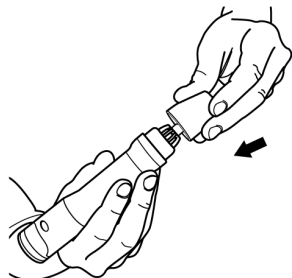

Setting Up the MimioCapture Eraser

The MimioCapture eraser is powered by a rechargeable lithium-ion battery. The eraser charges whenever the eraser is docked on the MimioCapture tray.

To set up the MimioCapture eraser

- ▶ Pull the plastic strip from the top part of the eraser to activate the rechargeable battery.

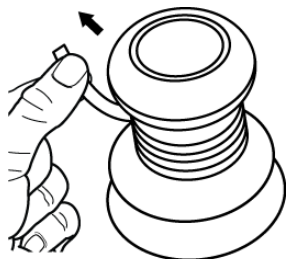

Charging the Pens and Eraser

The MimioCapture pens and MimioCapture eraser recharge quickly whenever they are docked on the MimioCapture tray.

To charge the pens and eraser

- ▶ Place each pen and the eraser into the appropriate part of the MimioCapture tray.

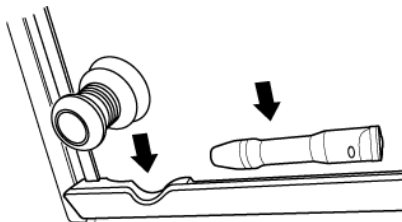

The status lights turn solid green when the pen or eraser is charging.

Setting Up MimioStudio Notebook for Capture



To begin capturing digital ink, you must first do the following:

- Set the size of your whiteboard in MimioStudio Settings.
- Start MimioStudio Ink Capture mode.

Setting the Whiteboard Size

Before you begin capturing digital ink, you must first set the size of your whiteboard in MimioStudio Settings. The default size is 96 inches by 48 inches.

To set the whiteboard size for a MimioCapture device

1. Right-click  in the notification area of the taskbar, and then choose  **Settings**. The MimioStudio Settings dialog box appears.
2. Click  **Ink Capture**.
3. If you have more than one MimioTeach bar connected to your computer, choose the device to change the size for from the **Device** list.
4. Do one of the following:
 - Choose a size from the **Surface Size** list.
 - Choose **Custom** from the **Surface Size** list and enter the desired values into the **Width** and **Height** boxes.
 - Click **Auto Size** and touch a MimioCapture pen to the whiteboard at the location shown in the **Auto Size** dialog box.

Starting Ink Capture Mode

Using MimioStudio Ink Capture mode, you can make notes on your whiteboard and instantaneously capture them into a MimioStudio Notebook.

To start Ink Capture mode

- ▶ Touch the tip of any MimioCapture pen to the whiteboard.
A new Notebook opens automatically for capturing your notes.

Using MimioCapture

MimioCapture can be used along with MimioTeach, without a projector, to record notes and drawings from your whiteboard. This is called capturing digital ink.

Capturing Digital Ink

When using Ink Capture mode, your notes are automatically captured in a MimioStudio Notebook. You can use the buttons on the MimioCapture tray to insert a new Notebook page, insert a copy of the current page into Notebook, or print the current Notebook page.

To capture digital ink

1. If your MimioTeach bar is not on, turn on your MimioTeach bar.
2. Write or draw on your whiteboard using the MimioCapture pens.
A new Notebook automatically opens on the connected computer and begins capturing digital ink.
3. Add, copy, and print pages as desired using the buttons on the MimioCapture tray.

Writing and Drawing Digital Ink

In Ink Capture mode, the MimioCapture pens and the MimioCapture eraser are used to draw and erase ink on your whiteboard.

By default, the color recorded matches the color of the MimioCapture pen, regardless of the color of the marker that is inserted.

- The MimioTeach stylus is for use with Interactive mode only. The stylus does not work with Ink Capture mode.

To draw digital ink

1. Choose one of the colored MimioCapture pens.
2. Draw on the whiteboard with the pen.

Keep the pen within 15 degrees of its perpendicular position to the whiteboard to ensure that the data is accurately captured.

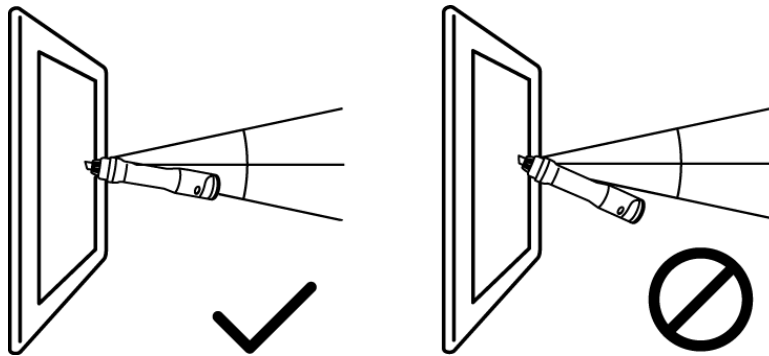

To erase digital ink

- ▶ Erase the ink from the whiteboard using the MimioCapture eraser.
 - Keep the eraser surface flat against the whiteboard to ensure that the data is accurately erased.



Adding, Copying, and Printing Notebook Pages

The buttons on the MimioCapture tray can be used to easily access features directly from your whiteboard. Using the buttons on the MimioCapture tray, you can insert a new Notebook page, insert a copy of the current page into Notebook, or print the current Notebook page.

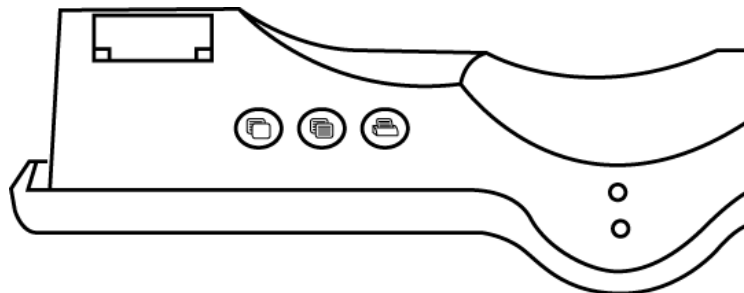
The following figure show the MimioCapture tray buttons.



The following table describes the functions of the MimioCapture tray buttons.

	New page	Inserts a new page into MimioStudio Notebook.
	Copy page	Inserts a duplicate of the current page into MimioStudio Notebook.
	Print page	Prints the current page.

Caring for MimioCapture

Review the following topics for information about cleaning, storing, and mounting your MimioCapture to a non-magnetic whiteboard.

- Cleaning MimioCapture
- Mounting MimioCapture to a Non-Magnetic Whiteboard

Cleaning MimioCapture

MimioCapture is designed to give you long and trouble-free service, while requiring very little maintenance.

You can easily clean your MimioCapture using the following items:

- Lint-free cloth.
- Isopropyl alcohol, diluted dishwashing detergent, or diluted glass cleaner.
- ⚠ If you use glass cleaner, make sure it does not contain ammonia.

To clean the MimioCapture

1. Disconnect the power cable and the connector bar.
2. Use the lint-free cloth to wipe the exterior of the MimioCapture tray, pens, and eraser.
3. Remove dirt and smudges with one of the cleaning solutions mentioned above.
 - ⚠ Avoid using liquids on any exposed charging contacts. Do not allow liquid into any openings on the equipment.
4. Reconnect the power cable and the connector bar.

Mounting MimioCapture to a Non-Magnetic Whiteboard

The MimioCapture tray attaches securely to any magnetic whiteboard. If you do not have a magnetic whiteboard, you can mount the MimioCapture tray to your whiteboard using the included metal plates.

To mount MimioCapture to a non-magnetic whiteboard

1. Place the metal plates against the back of the MimioCapture tray as shown.

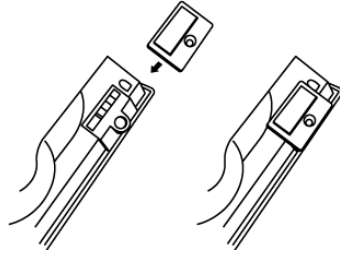

- Make sure that the recess on each plate is inserted into the recess on the back of the MimioCapture tray.

2. Remove the paper backing from the adhesive strips to expose the adhesive.

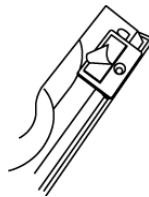

3. Press the MimioCapture tray firmly along the bottom-left edge of the whiteboard as shown.

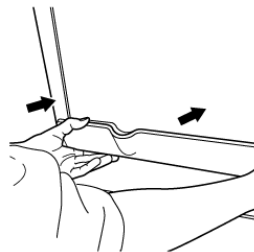

Chapter 5

MimioVote

MimioVote is a wireless, interactive, student response system. Using MimioVote, you can easily and quickly gather student responses. This quick feedback from students allows you to make sure each student is keeping up and adjust your lesson accordingly.

What's Included

The MimioVote package contains the following items:

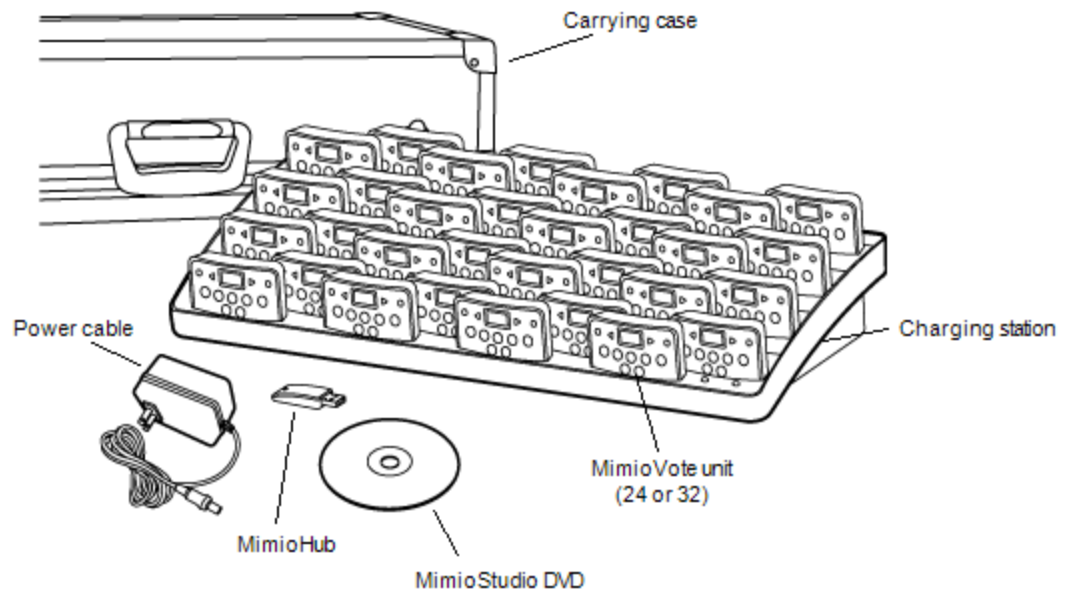

If you are missing any of the items above, contact Customer Support.

About MimioVote

Your MimioVote system comes with a charging station and either 24 or 32 MimioVote units. You can combine two MimioVote systems for a total of up to 64 units.

About the MimioVote Station

The MimioVote station is used to recharge and store all of your MimioVote units.

You can place any MimioVote unit into any slot on the MimioVote station. The number assigned to each unit is automatically determined by the number of the slot that the unit is inserted into. There is no need to match a particular unit to a particular slot on the

MimioVote station. Once a unit is inserted into the MimioVote station, the unit number appears in the unit display.

The following figure shows the major components of the MimioVote station.

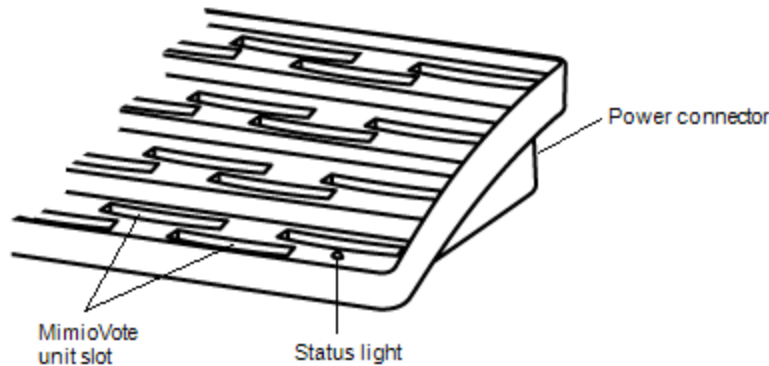

Status Lights

The status light visually shows the status of the MimioVote station.

Off	Not receiving power; Power cable is not connected.
Solid Green	MimioVote is connected and receiving power; MimioStudio software is running.
Flashing Green	MimioVote is connected or connecting, and receiving power; MimioStudio software is not running.
Solid Amber	MimioVote cannot find an available MimioHub.
Flashing Amber	MimioVote is searching for an available MimioHub.

About the MimioVote Units

The MimioVote system includes either 24 or 32 MimioVote units. The MimioVote units slide into the MimioVote station to recharge or to store.

When conducting activities, the buttons on the MimioVote unit light up depending on what answers are available to the student. The available answers are determined by the teacher when the question is created. For example, if the question is a True/False question, only the ☑ and ☒ buttons are illuminated on the MimioVote unit. The A, B, C, D, and E buttons will not light up and will not register a response if pressed.

By default, each button on the MimioVote unit is illuminated with a different color light. You can choose to turn off the colors and have all the buttons illuminated with a white light. For information about changing the button colors, see [Adjusting the Vote Settings](#).

The following figure shows the major components of the MimioVote unit.

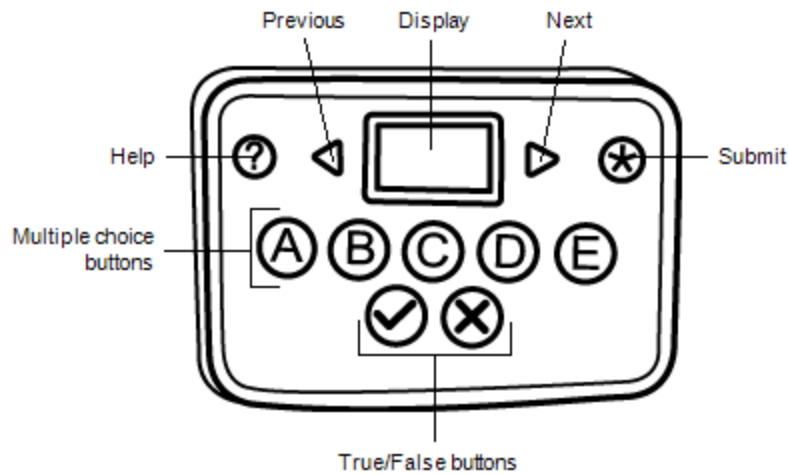

About the Software

MimioStudio software includes several features especially for use with your MimioVote system. MimioStudio Notebook and Gallery include everything you need to create activities to conduct with your students. The MimioStudio Vote Toolbar and MimioStudio Quick Vote include all the tools you need for conducting activities and gathering student responses. And, the MimioStudio Gradebook stores the information and results for all of your class activities.

About MimioStudio Notebook

You can use MimioStudio Notebook to create any type of MimioVote activity. Activities are created by adding question objects to Notebook pages. The Questions and Results folder in MimioStudio Gallery includes a wide variety of pre-designed question objects to make creating activities in Notebook quick and easy.

For more information about using MimioStudio Notebook and Gallery, see About MimioStudio.

The following figure shows the major components of MimioStudio software.

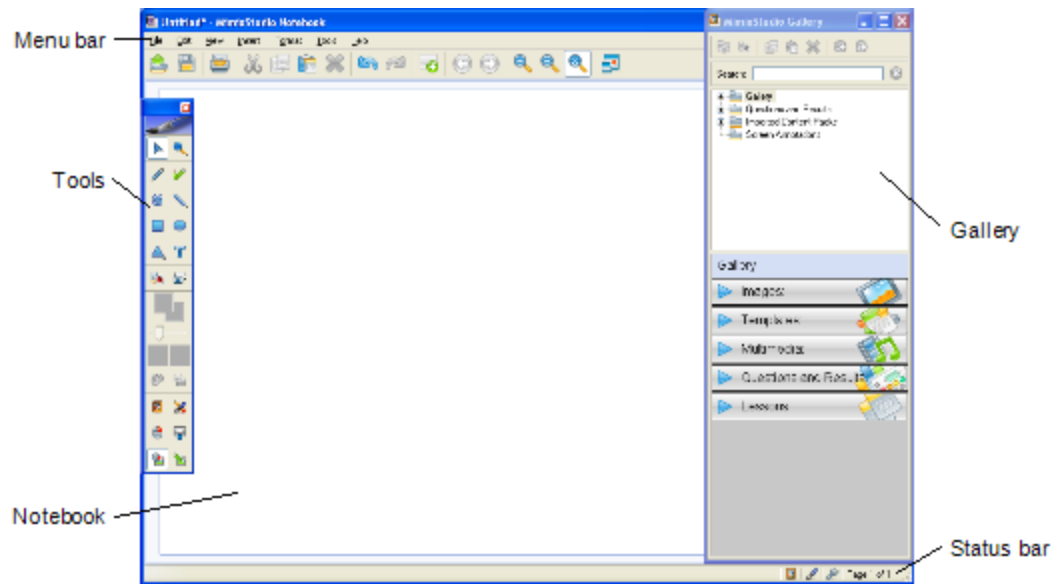

About the Vote Toolbar

The Vote Toolbar includes all the tools you need for taking attendance, conducting class activities, gathering student responses, and viewing results. The Vote Toolbar is available in MimioStudio Notebook and Microsoft PowerPoint.

The following figure shows the major features of the Vote Toolbar in MimioStudio Notebook.

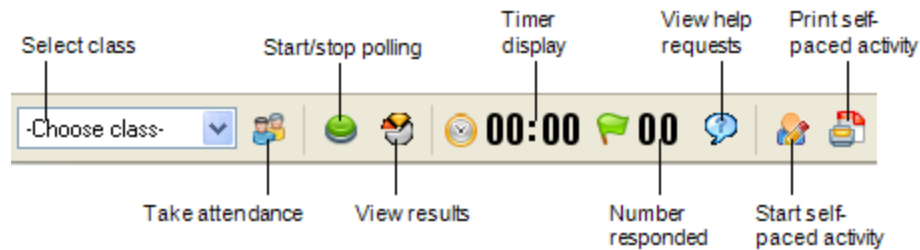

The following figure shows the major features of the Vote Toolbar in Microsoft PowerPoint.

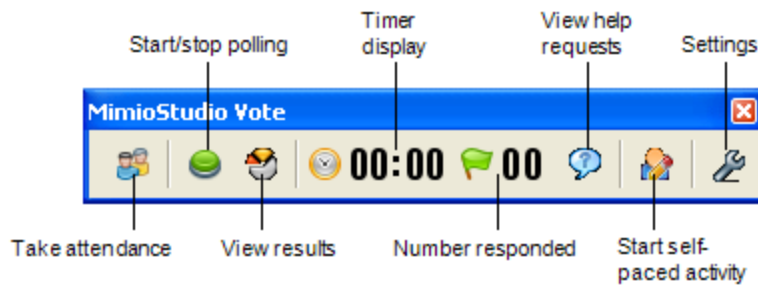

About MimioStudio Quick Vote

You can use MimioStudio Quick Vote to ask questions that are not a part of a Notebook or PowerPoint MimioVote activity. You can use Quick Vote to add a question at any time during a Teacher-Led activity.

The following figure shows the major features of the MimioStudio Quick Vote.

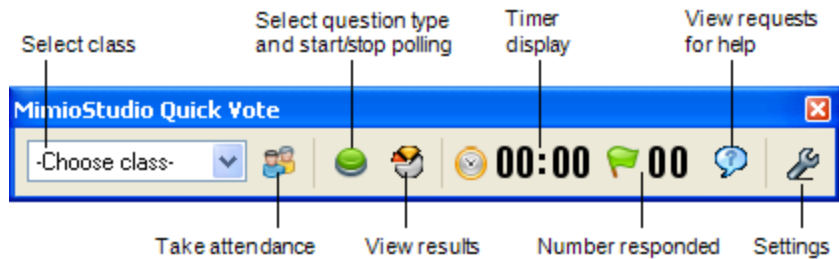

About MimioStudio Gradebook

MimioStudio Gradebook stores the results for all of your class activities. Student responses gathered using the MimioVote system are automatically saved to the Gradebook along with complete information for each question. You can also manually add activities that were not conducted using the MimioVote system, making it easy to keep all your grades in one location.

The following views are available in Gradebook, giving you easy access to the information you want to view:

- Classes View
- Class View
- Date View
- Activity View

Classes View

The classes view displays a list of all of your saved classes, the number of students in each class, and the average grade for all students in the class.

Classes list

Add class

Class Name	Number of Students	Class Score
Algebra	5	75.5%
Biology	11	80.0%
Chemistry	6	75.0%
History	6	92.0%

Class names

Number of students per class

Average score per class

Class View

The Class view displays a list of all students in the selected class and all dates on which any activities were conducted. Each date column shows the average grade for each student, for all activities that were conducted on that date.

From the Class view, you can also view the Class pane. The Class pane displays the name of the class, number of students in the class, and the number of activities that have been conducted with the selected class.

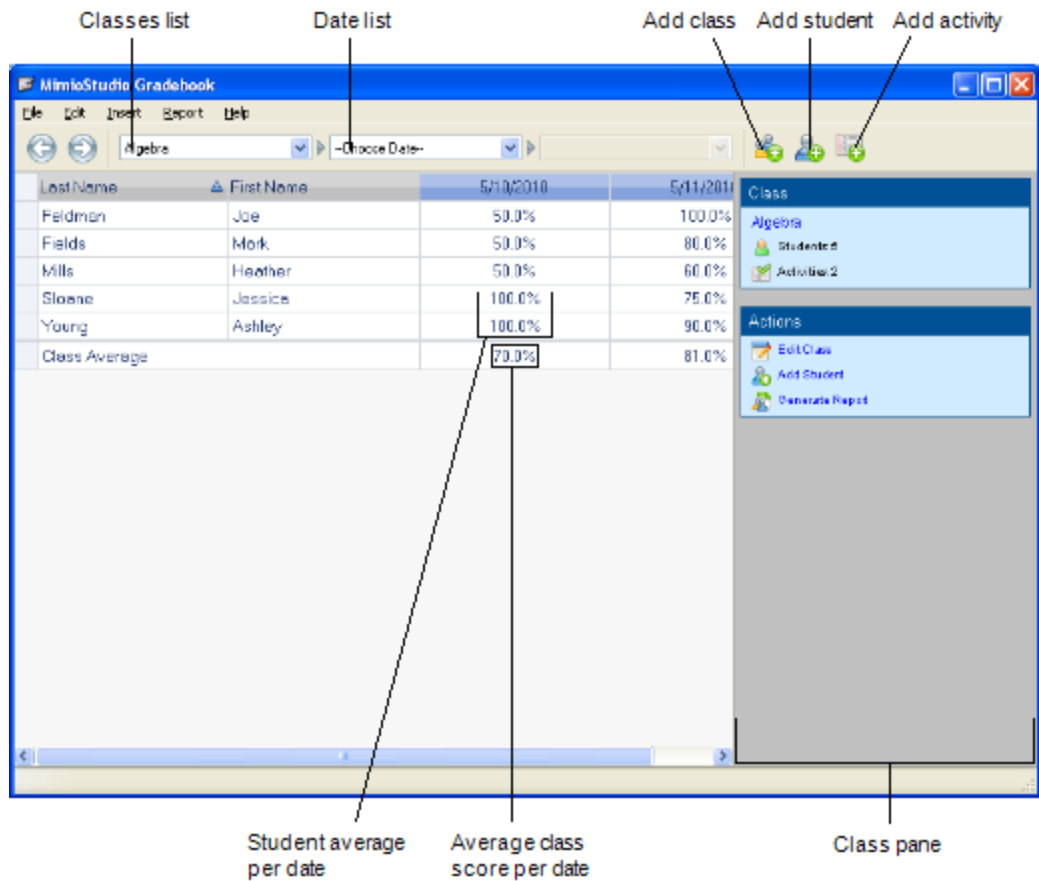

Date View

The Date view displays a list of all students in the selected class. The Attendance column shows the attendance status for each student on the selected date. The activity columns show the grade that each student received for each activity conducted on the selected date.

From the Date view, you can also view the Activity pane. The Activity pane displays the name of the activity, activity type, total number of question, and the weight of the activity.

The screenshot shows the MimioStudio Gradebook interface. At the top, there are several dropdown menus and buttons: 'Classes list', 'Date list', 'Activity list', 'Add class', 'Add student', and 'Add activity'. The main area contains a table with columns for 'Last Name', 'First Name', 'Attendance', and 'Test'. The 'Test' column shows scores for each student, and a 'Class Average' row at the bottom shows an average score of 70.0%. To the right of the table is an 'Activity' pane showing details for the selected activity, including its name, type, and weight. Below the table, there are three callouts: 'Student attendance' pointing to the 'Attendance' column, 'Student average per activity' pointing to the 'Test' column, and 'Average class score per activity' pointing to the 'Class Average' row. The 'Activity pane' is also labeled at the bottom right.

Last Name	First Name	Attendance	Test
Feldman	Joe	Present	50.0%
Fields	Mork	Present	50.0%
Mills	Heather	Present	50.0%
Sloane	Jessica	Present	100.0%
Young	Ashley	Present	100.0%
Class Average			70.0%

Activity View

The Activity view displays a list of all students in the selected class. The Average column shows the grade for each student for the selected activity. Each question column shows the response that each student provided.

The Activity pane displays the name, type, and weight of the selected activity.

From the Activity view, you can also view the Question pane. The Question pane displays the question text, the available and correct answers, the question snapshot, and the question weight.

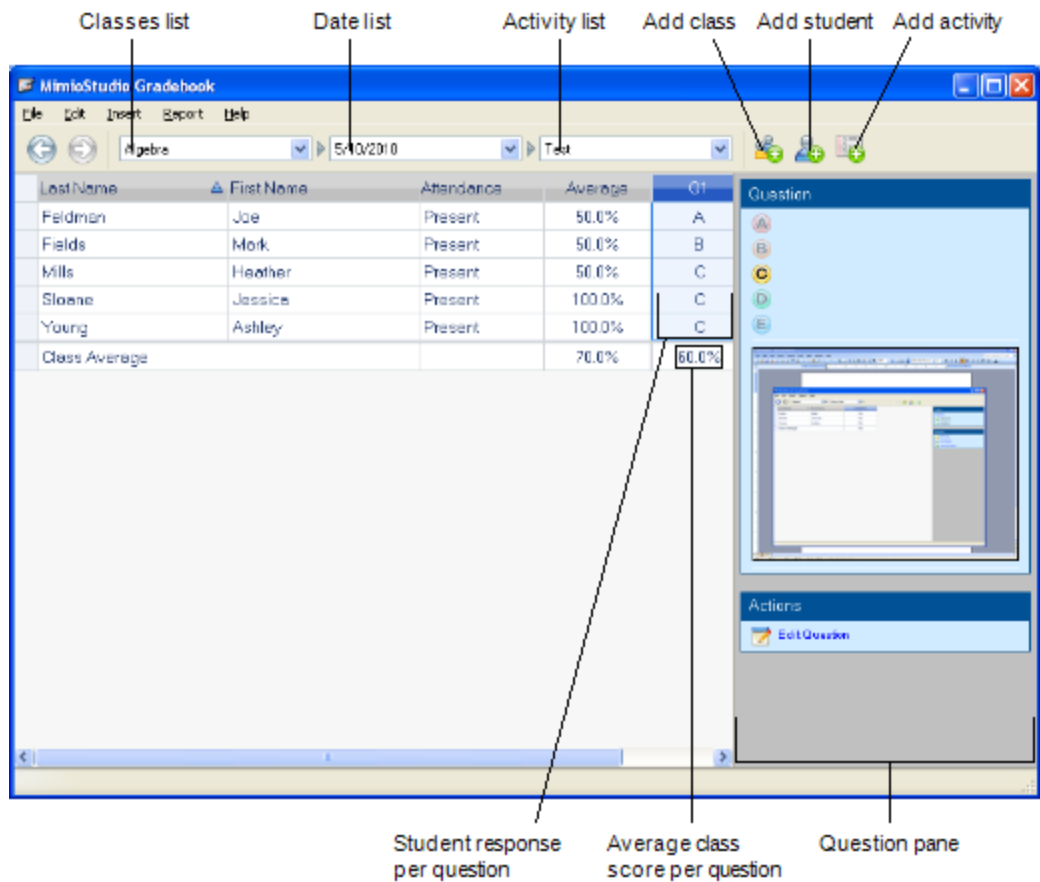

Student Pane

You can view the Student pane from Class view, Date view, or Activity view. The Student pane displays the name, student ID number, MimioVote unit number, and address for the selected student.

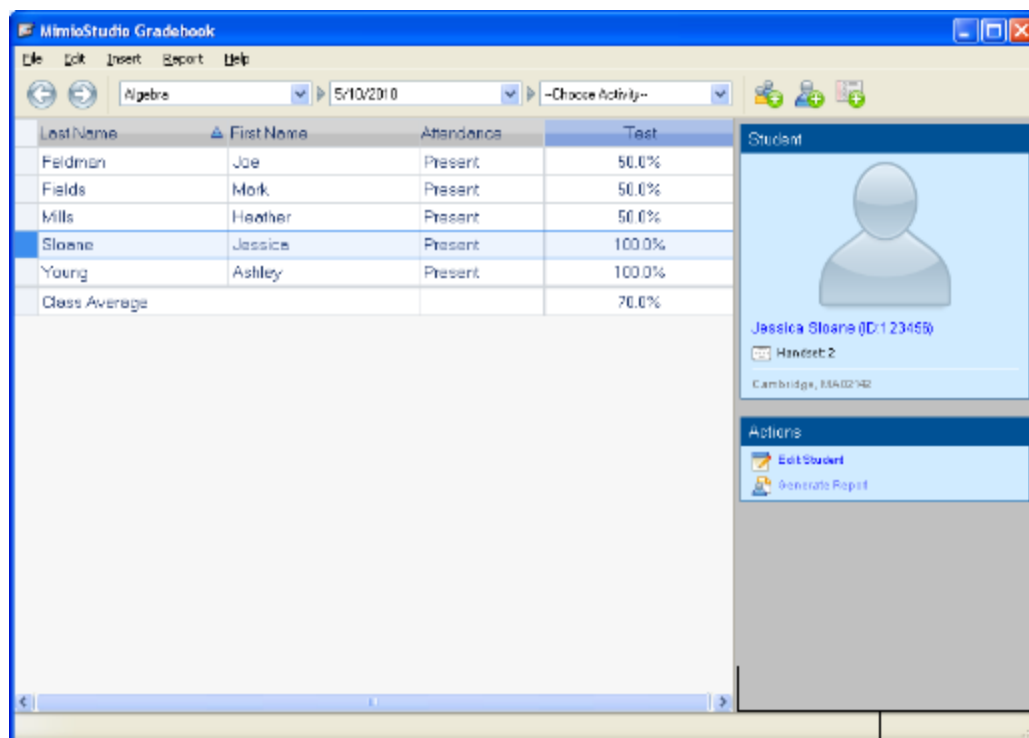

Student pane

Getting Started

Setting up the MimioVote system is quick and easy. You can link your MimioVote system to your computer using the included MimioHub. Or, if you have MimioTeach, you can link the MimioVote system to your computer using the MimioHub that you already have installed.

Setting Up MimioVote

Once you have installed the MimioStudio software on your computer, you can quickly set up MimioVote.

- Each MimioVote unit is powered by a rechargeable lithium-ion battery. The battery recharges whenever the unit is docked in the MimioVote station. Charging the battery for the first time will take approximately six hours; when fully discharged, recharging the battery will take approximately twelve hours.

To set up MimioVote

1. Pull the plastic strip from each MimioVote unit to activate the rechargeable battery.

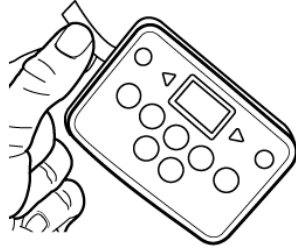

2. Insert each MimioVote unit into a slot on the MimioVote station.

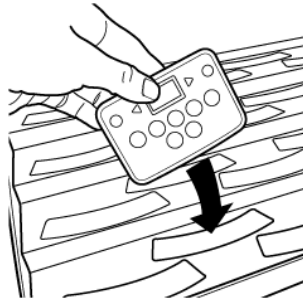

3. Plug the power cord into the power connector on the back of the MimioVote station.

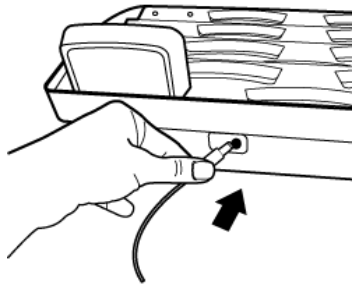

4. Plug the other end of the power cord into a power outlet.

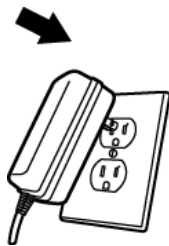

5. Plug the MimioHub into an available USB port on your computer.

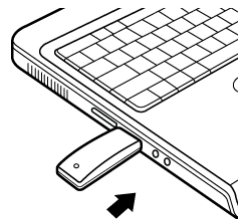

 If you already have a MimioHub installed on your computer, a dialog box appears asking if you want to connect the MimioHub to the MimioVote system. Click **Yes**

to link the MimioVote system to your existing MimioHub.

Adding a Second MimioVote System

Each MimioVote system includes either 24 or 32 MimioVote units. For larger classes, you can combine two MimioVote systems for a total of up to 64 units.

 You can use the same MimioHub to connect all of your MimioClassroom devices to your computer.

To add a second MimioVote system

1. Set up the MimioVote station and units as described in [Setting Up MimioVote](#). Once the power is connected to the MimioVote system, the previously installed MimioHub will detect the new system.
2. When prompted by the software, click **Yes** to connect the new system to the MimioHub.



The second system is connected to your computer and the appropriate numbers are assigned to each MimioVote unit automatically.

 If you do not see the prompt, or you want to connect the system at a later time, see [Adjusting the Classroom Devices Settings](#) for information about connecting available devices to your computer.

Using MimioStudio Gradebook

You can use MimioStudio Gradebook to store information for all of your classes, students, and class activities. Student responses gathered using the MimioVote system are automatically saved to the Gradebook along with complete information for each question. You can also manually add activities that were not conducted using the MimioVote system, making it easy to keep all your grades in one location.

Several ways to access MimioStudio Gradebook are shown in the following table.

To start from the	Do this
Desktop	Double-click  on the desktop.
Taskbar	Right-click  , and then choose  Gradebook .
Start menu	Point to Programs, MimioStudio, Tools , and then choose MimioStudio Gradebook .

Setting Up the Gradebook

Before you begin using your MimioVote system to conduct activities, you must first set up MimioStudio Gradebook. You can add as many classes as you want to Gradebook, and then add students to each of your classes.

Creating a Class

You can create as many classes as you want in Gradebook. Once you have created a class, you can add students to the class by manually entering all student names and information, or you can import a list of students.

To create a class



1. Click  on the Gradebook toolbar.
The Add Class dialog box appears.
2. Enter a name for the class in the **Name** box, and then click **Add**.
The class is added to your class list.

Adding Students

The number of students you can have in each class depends on the number of MimioVote units you have. You can combine two MimioVote systems for up to 64 units.

Each student that you add to a class is automatically assigned a MimioVote unit number.

To add a student to a class

1. Select the class to add a student to.
2. Click  on the Gradebook toolbar.
The Add Student dialog box appears.
3. Enter the name, student ID number, and address for the student.
 The MimioVote handset ID is assigned automatically.
4. Click **Add**.
The student is added to the class.

Importing a List of Students

You can add students to a class manually by entering all student names and information, or you can import an existing list of students into a class.

You can import students from a Unicode text file (TXT) or a Comma separated value file (CSV). Each student must have at least a first or last name assigned to them in order to be imported.

The following fields are supported for importing into Gradebook.

- | | |
|--------------|------------|
| ■ StudentID | ■ Address |
| ■ FirstName | ■ City |
| ■ MiddleName | ■ State |
| ■ LastName | ■ ZIP Code |
| ■ Gender | ■ Country |
| ■ Birthdate | |

Each student that you add to a class is automatically assigned a MimioVote unit number.

To import a class list

1. In Gradebook, select the class you want to import the student list into.
2. From the **File** menu, choose **Import**, and then choose **Students**.
The Open dialog box appears.

3. Navigate to and select the file you want to import, and then click **Open**.
The students are added to the selected class.

Adding Activities

You can keep track of all of your student scores using Gradebook. Scores for all MimioVote activities are automatically saved to the Gradebook. You can also manually enter activities that were not performed using MimioVote.

To add an activity

1. Select the class to add the activity to.
2. Click  on the Gradebook toolbar.
3. In the **Add Activity** dialog box, do the following:
 - a. Enter a name for the activity in the **Name** box.
 - b. Choose the type of activity to add from the **Type** list.
 - c. Choose the month, date, and year that the activity was performed.
 - d. Enter a weight for the activity in the **Weight** box.
 - e. Click **Add**.The activity is added and displayed in the Gradebook.
4. Enter a grade for each student in the **Average** column.

Modifying the Gradebook

You can modify the information in the MimioStudio Gradebook in the following ways:

- Edit Student Information
- Remove a Student
- Editing Activities
- Editing Questions

Editing Student Information

You can edit any information for an existing student, including the student name, student ID number, MimioVote unit ID number, and address.

To edit student information

1. Select the student to edit.
2. Click  **Edit Student** on the Student pane.
The Edit Student dialog box appears.
3. Make any desired changes to the student information.
4. Click **OK** to save your changes.

Removing a Student

You can delete a student from a class at any time. Deleting a student permanently removes the student from the class and removes all of their activity results from the Gradebook.

To remove a student from a class

1. Select the class that contains the student you want to remove.
2. Select the student to remove.

3. Choose **Delete** from the **Edit** menu.
4. Follow the instructions in the **Confirm Delete** dialog box, and then click **OK**.
The selected student and all information for the selected student is permanently deleted from the Gradebook.

Editing Activities

You can edit the name, type, and weight for an activity at any time.

To edit an activity

1. Select the activity to edit.
2. Click  **Edit Activity** on the Activity pane.
The Edit Activity dialog box appears.
3. In the **Edit Activity** dialog box, you can do any of the following:
 - Enter a new name for the activity in the **Name** box.
 - Choose a different activity type from the **Type** list.
 - Enter a new weight for the activity in the **Weight** box.
4. Click **OK** to save your changes.

Editing Questions

Each time you stop polling for a question, a copy of the question, along with the correct answer, is saved to the Gradebook. You can edit the question text, correct answer, question type, and question weight at any time in Gradebook.

For example, if the answer that was selected as the correct answer in the question object is incorrect, you can change the answer in the Gradebook to automatically update the student scores.

 Changing the answer for a question in the Gradebook does not automatically change the answer in the question object in Notebook. To change the answer for subsequent activities, you must make the correction to the question object in Notebook.

To edit a question

1. Select the question to edit.
2. Click  **Edit Question** on the Question pane.
3. In the **Edit Question** dialog box, you can do any of the following:
 - Edit the question or answer text under **Question Information**.
 - Click the button to the left of the correct answer to change the correct answer for the question.
 - Choose a different question type from the **Type** list.
 - Enter a new weight for the question in the **Weight** box.
4. Click **OK** to save your changes.

Generating Reports

You can generate a variety of reports from MimioStudio Gradebook. Reports are generated as HTML files and are displayed in your default Web browser.

You can generate the following types of reports:

- Class Grade Report- a grade report for all students in the selected class
- Class Activity Report - a detailed report for the selected activity
- Student Summary Report- a summary report of all activities for the selected student
- Student Activity Report - a detailed report for all selected activities for the selected student

You can generate reports from the Class, Activity, and Student panes in Gradebook or from the Report menu.

Exporting a List of Students

You can export a list of students from any class you have saved in Gradebook to a Unicode tab-delimited text file (TXT).

To export a list of students

1. Display the class that contains the students you want to export.
2. From the **File** menu, choose **Export**, and then choose **Students**.
The Export Students dialog box appears.
3. Select **Export student information**, and then click **OK**.
The Save As dialog box appears.

Archiving Classes

You can archive your classes by exporting a class to a MimioStudio Gradebook Archive (MVA) file. The archive file contains all student, activity, and results information. You can use this file to backup your classes or to move classes from one Gradebook to another.

To archive a class

1. From the **File** menu, choose **Export**, and then choose **Class**.
The Export Class dialog box appears.
2. Select **Export class information**, and then click **OK**.
The Save As dialog box appears.

Exporting Results

You can export class and activity results from the Gradebook to a Unicode tab-delimited text file (TXT) for use in another application. You can export the following information:

- Class results - includes the class average for each student in the selected class.
- Class and activity results - includes the class average for each student as well as the grade each student received for each activity
- Activity results - includes the grade for each student for the selected activity.

To export class results

1. From the **File** menu, choose **Export**, and then choose **Class**.
The Export Class dialog box appears.
2. Select **Export class results**, and then click **OK**.
The Save As dialog box appears.
3. Enter a name for the file in the **File name** box, and then click **Save**.

To export class and activity results

1. From the **File** menu, choose **Export**, and then choose **Class**.
The Export Class dialog box appears.
2. Select **Export class and activity results**, and then click **OK**.
The Save As dialog box appears.
3. Enter a name for the file in the **File name** box, and then click **Save**.

To export activity results

1. From the **File** menu, choose **Export**, and then choose **Activity**.
The Export Activity dialog box appears.
2. Select **Export activity results**, and then click **OK**.
The Save As dialog box appears.
3. Enter a name for the file in the **File name** box, and then click **Save**.

Opening Archived Classes

You can open your archived class files at any time by importing the archive (MVD) file into the Gradebook. Once imported, all classes in the archive file will appear along with your current classes in the Gradebook.

To open archived classes

1. Choose **Import Classes** from the **File** menu.
The **Open** dialog box appears.
2. Navigate to and select the archive file to import, and then click **Open**.

Creating Activities

You can create MimioVote activities in MimioStudio Notebook or Microsoft PowerPoint.

-  You can also use MimioStudio Quick Vote to ask questions that you did not previously create in Notebook or PowerPoint.

You can add the following types of questions to your activity:

- TF - True/False, Yes/No, or Agree/Disagree
- AB - Multiple choice, two possible answers
- ABC - Multiple choice, three possible answers
- ABCD - Multiple choice, four possible answers
- ABCDE - Multiple choice, five possible answers



Creating Activities in Notebook

You can use MimioStudio Notebook to create any type of MimioVote activity. Activities are created by adding question objects to Notebook pages. The Questions and Results folder in MimioStudio Gallery includes a wide variety of pre-designed question objects to make creating activities in Notebook quick and easy.

-  Each question object contains a single question, and each question must be on a separate Notebook page.

Once you've added a question object to an activity, you can customize the object properties to change the appearance or behavior of the question object.

To create an activity in Notebook

1. Open a new or existing Notebook.
2. In MimioStudio Gallery, click the plus sign next to the **Questions and Results** folder, and then select the **Questions** folder.
3. Drag the desired question object from the Gallery into the Notebook.
 Only one question object can be placed on each Notebook page.
4. Enter the question text in the Question box.
5. Enter an answer choice for the question in each of the Answer boxes.
6. Select the correct answer.
7. To add another question to the activity, do the following:
 - a. Click  to add a new page to the Notebook.
 - b. Repeat steps 3-6 to add a question to the new page.

Creating an Activity in PowerPoint

Creating Activities in PowerPoint®

You can use the MimioStudio Vote Add-in to create any type of MimioVote activity in Microsoft® PowerPoint®. MimioVote activities are created by adding question slides to a PowerPoint® presentation. The MimioStudio Vote Add-in includes a variety of pre-formatted question slide templates to make creating activities in PowerPoint® quick and easy.

To create an activity in PowerPoint®



1. Open a new PowerPoint® presentation.
2. Click **Insert Slide** on the Add-Ins toolbar, and then choose the type of question slide you want to add.
The slide is added to the presentation.
3. Enter the question text in the Question box.
4. Enter an answer choice for the question in each of the Answer boxes.
5. Click **Set Correct Answer** on the Add-Ins toolbar.
The Set Correct Answer dialog box appears.
6. Select the correct answer for the question.
7. Enter a weight for the question in the **Question Weight** box, and then click **OK**.
8. Repeat steps 2-7 to add all additional questions to the activity.

Modifying Question Objects

MimioStudio Gallery includes a variety of pre-designed question objects for creating MimioVote activities. Once you add a question object to a Notebook page, you can use the question objects as is or you can choose to change the properties of the question object. You can change the question type, animation for correct answers, and question weight.

To modify a question object

1. Click  at the bottom-right of the question object you want to modify.
The question object properties appear.

2. In the question object properties, you can do any of the following:
 - To change the question type, select an available question type.
 - To change the correct answer animation, select an available animation.
 - To change the weight of the question, enter the weight for the question in the weight, , box.
 3. Click  to save your changes and display the question object.
- Creating an Activity in PowerPoint

Importing Standard Assessments

You can import standard assessments into MimioStudio Notebook for use with MimioVote. Only files that have been exported from ExamView® as Blackboard® (6.0-7.0) format can be imported into Notebook.

-  For information about installing ExamView®, and downloading and exporting ExamView® files, see the ExamView® documentation.

To import a standard assessment

1. Start MimioStudio Notebook, and then click .
The Open dialog box appears.
 2. Navigate to and select the file to import, and then click **Open**.
The file is imported and displayed in Notebook.
- Creating an Activity in PowerPoint

Printing Activities

You can print an activity from Notebook to use as a self-paced activity. Normally, when you print a Notebook presentation, each page of the Notebook prints on a separate page. However, you can choose to print the activity so that multiple questions appear on a single page.

-  When you choose to print an activity, an HTML file is created from the Notebook activity. The HTML file contains all question and answer text, but no images. You can choose to print or save the HTML file.

To print an activity

1. Open the activity to print.
 2. Click  on the Vote Toolbar.
The Select Class dialog box appears.
 3. Select the class to print the activity for from the **Class** list, and then click **OK**.
The activity is displayed as an HTML file in your default Web browser.
 4. Choose **Print** from the **File** menu.
- Creating an Activity in PowerPoint

Using the MimioVote Unit

Each MimioVote unit is assigned to one student per class. Students should use their assigned MimioVote unit each time an activity is conducted.

By default, each button on the MimioVote unit is illuminated with a different color light. You can choose to turn off the colors and have all the buttons illuminated with a white light. For information about changing the button colors, see *Adjusting the Vote Settings*.

Answering Questions

Depending on the type of question being asked, the appropriate buttons are illuminated on the MimioVote unit.

For example, when polling is started for a True/False question, only the ☑ and ☒ buttons are illuminated on each MimioVote unit. The A, B, C, D, and E buttons are not illuminated and will not register a response if pressed.

Answering Questions for Teacher-Led Activities

For teacher-led activities, questions are answered one at a time as they are displayed.

To answer a question

- ▶ Press the button on the MimioVote unit that corresponds to the correct answer for the displayed question.

Answering Questions for Self-Paced Activities

For self-paced activities, questions can be answered in any order. The current question number is displayed on the MimioVote unit. For each question, the available answer buttons are illuminated, as well as the next and previous buttons.

To answer questions in a Self-Paced activity

1. Press the button on the MimioVote unit that corresponds to the correct answer for the first question.

The unit automatically advances to the next question. The current question number appears in the unit display.

2. Repeat step 1 for each remaining question in the activity.

 You can change your answer to any question at anytime before submitting your answers. Use ◀ and ▶ to move through the questions and review or change any answers as desired. The currently selected answer button flashes.

3. When all questions in the activity have been answered, press ⓧ.

 You must answer every question before submitting the activity. The ⓧ button will not become available until all questions have been answered.

Requesting Help

A student can request help or request to ask a question at anytime using the MimioVote unit.

To request help

- ▶ Press ? on the MimioVote unit.

For information about viewing help requests, see *Viewing Requests for Help*.

Using the Vote Toolbar

The Vote Toolbar includes all the tools you need for taking attendance, conducting class activities, gathering student responses, and viewing results.

Taking Attendance

You can quickly take attendance and record the results using MimioVote.

To take attendance

1. Select the class to take attendance for from the Class list.
2. Click  on the Vote Toolbar.

A list of all students in the selected class is displayed in the Attendance window.

As each student indicates that they are present, the icon for that student is illuminated.

A student indicates they are present by pressing  on their MimioVote unit.

3. Close the **Attendance** window to stop taking attendance and save the results to the Gradebook.

Using the Timer

The timer on the Vote Toolbar displays the amount of time that has passed since you started polling.

-  The timer automatically starts each time you start polling and automatically stops each time you stop polling.

Conducting Activities

Using MimioVote, you can perform teacher-led or self-paced activities. Review the following topics for information about conducting activities.

- Conducting a Teacher-Led Activity
- Asking Questions Using Quick Vote
- Conducting a Self-Paced Activity
- Viewing Question Results
- Viewing Session Results
- Viewing a List of Students that Have Not Responded





Conducting a Teacher-Led Activity

Once you have created an activity in Notebook or PowerPoint®, you can perform the activity with your class. When performing a Teacher-Led activity, the questions are displayed one at a time for the students.

-  You can ask questions that you did not previously create in Notebook or PowerPoint at any time during a Teacher-Led activity using MimioStudio Quick Vote.

To conduct a teacher-led activity







1. Open the Notebook or PowerPoint presentation that contains the activity you want to conduct.
2. Select the class that will participate in the activity from the Class list.

3. *(Required for PowerPoint only.)* Set the display to Full Screen or Slide Show view.
 4. Display the first question for the class.
 5. Click  on the Vote Toolbar to start polling for the question.
 In Notebook, you can also start and stop polling directly from the question object by clicking .
- When all students have responded, polling for the question stops and the results are saved to the Gradebook.
6. To stop polling for a question before all students have responded, click .
- Polling stops and the results are saved to the Gradebook.
7. Repeat steps 4-6 for each remaining question in the activity.
 8. When all questions in the activity have been answered, close the presentation and the Vote Toolbar to stop the activity.

Asking Questions Using Quick Vote

Using the MimioStudio Quick Vote, you can ask questions that you did not previously create in Notebook or PowerPoint at any time during a Teacher-Led activity.



To ask a question using Quick Vote

1. Do one of the following to start Quick Vote:
 - Right-click , and then choose  **Quick Vote**.
 - *(Interactive mode Only)* Press the **Launch** button, , on the MimioTeach bar, and then click  **Quick Vote**.
2. Select the class that will participate in the activity from the Class list.
3. Click , and then choose the question type to start polling for the question.
When all students have responded, polling for the question stops.
4. To stop polling for a question before all students have responded, click .
5. Click the letter that corresponds to the correct answer for the question.
The results for the current question are saved to the Gradebook along with a screen shot.

Conducting a Self-Paced Activity

Once you have created an activity in Notebook or PowerPoint®, you can perform the activity with your class. When performing a Self-Paced activity, each student must have a printed copy of all questions in the activity. For information about printing activities, see Printing Activities.



To conduct a self-paced activity

1. Open the Notebook or PowerPoint presentation that contains the activity you want to conduct.
2. Select the class that will participate in the activity from the Class list.
3. *(Required for PowerPoint only.)* Set the display to Full Screen view.
4. Click .
The Self-Paced Test window appears.
5. (Optional) Use the  and  buttons to set the timer.

The timer displays the amount of time left for the activity.

💡 If you do not set the timer, the timer displays the amount of time that has passed since polling started.

6. Click  to start polling for all questions.

Each student can move through the questions at their own pace using the  and  buttons on their MimioVote unit.

When all students have submitted their responses or when the timer runs out, polling for the activity stops and the results are saved to the Gradebook.

7. To stop polling for an activity before all students have submitted their response or before the timer runs out, click .

All results for the activity are saved to the Gradebook.

Viewing Question Results

You can instantly view the results for a question as soon as you stop polling. There are a variety of ways to view the results for a question.

To view the result for a question

1. Click , and then choose **Question Results**.

The Question Results window appears.

2. To modify the appearance of the results, click .

💡 You can change the type and colors of the graph shown. You can also choose to show the number or percentage of correct answers.

3. Click  to save your changes and view the results.

Viewing Activity Results

You can instantly view the results for an activity as soon as you stop polling. There are a variety of ways to view the results for an activity.

To view the result for an activity

1. Click , and then choose **Activity Results**.

The Activity Results window appears.

2. To modify the appearance of the results, click .

3. Click  to save your changes and view the results.

Viewing a List of Students that Have Not Responded

While you are polling a class, the number of students that have responded to the current question is displayed on the Vote Toolbar. You can quickly view a list of all students that have not yet responded.

To view a list of students that have not responded

- ▶ Click  on the Vote Toolbar.

A list of students that have not yet responded is displayed in a separate window.

Viewing Requests for Help

Using their MimioVote unit, a student can request help or request to ask a question at anytime. For information on using the MimioVote unit to request help, see Requesting Help.

You can quickly view a list of all students that have requested help.

To view students requesting help

1. Click  on the Vote Toolbar.
A list of students that have requested help is displayed in a separate window.
2. Click the icon for a student to remove that student from the list.

Caring For MimioVote

Review the following topics for information about cleaning and storing your MimioVote system.

- Cleaning MimioVote
- Storing MimioVote

Cleaning MimioVote

The MimioVote is designed to give you long and trouble-free service, while requiring very little maintenance.

You can easily clean your MimioVote using the following items:

- Lint-free cloth.
- Isopropyl alcohol, diluted dishwashing detergent, or diluted glass cleaner.
 If you use glass cleaner, make sure it does not contain ammonia.

To clean the MimioVote station and units

1. Disconnect the power cable.
2. Use the lint-free cloth to wipe the exterior of the MimioVote station and each MimioVote unit.
3. Remove dirt and smudges with one of the cleaning solutions mentioned above.
 Avoid using liquids on any exposed charging contacts. Do not allow liquid into any openings on the equipment.
4. Reconnect the Power cable.

Storing MimioVote

The MimioVote system comes with a carrying case for your MimioVote station and MimioVote units. You can use this case to transport the system and to safely store your MimioVote system when not in use.

Chapter 6

MimioView

MimioView works seamlessly with MimioStudio software to display documents, three-dimensional objects, and microscope slides for your entire class to view. You can use MimioView to display still images or live video.

What's Included

The MimioView package contains the following items:

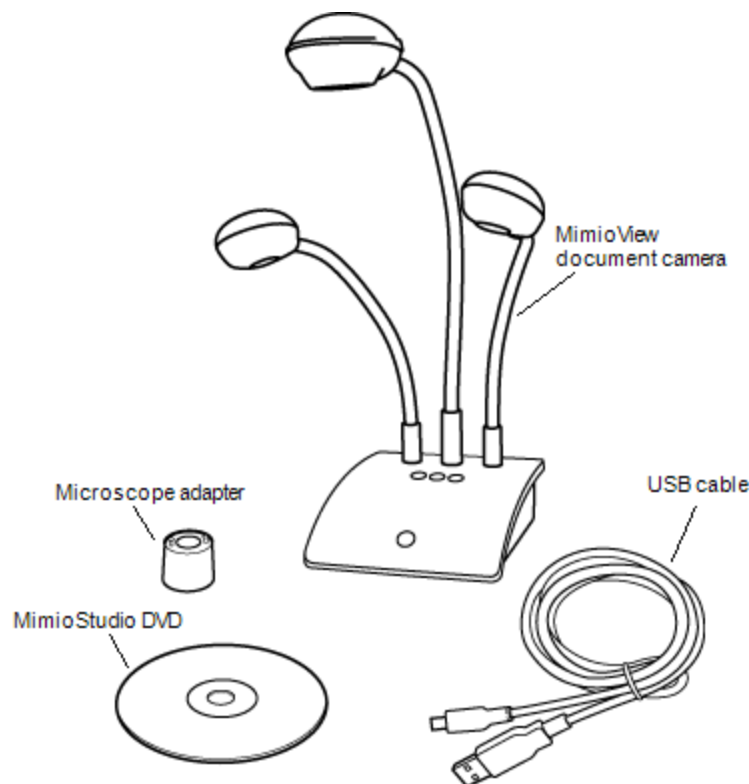

If you are missing any of the items above, contact Customer Support.

About MimioView

You can use the MimioView camera to display documents, three-dimensional objects, and microscope slides.

The MimioView camera and lamps are each attached to the MimioView base by a flexible, gooseneck. This allows you to precisely position the camera and each lamp for the best possible view of the object you are displaying.

The following figure shows the major components of the MimioView camera.

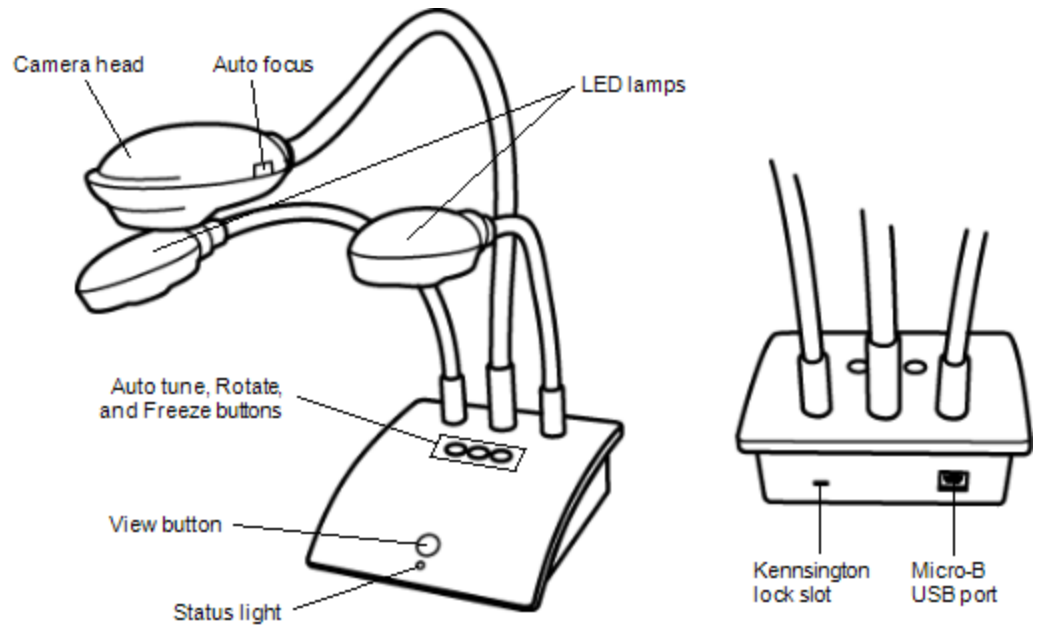

Status Lights

The status light visually shows the status of the MimioView camera.

Off	Not receiving power; USB cable is not connected or computer is turned off.
Solid Green	MimioView is connected and receiving power; MimioStudio software is running.
Flashing Green	MimioView is connected and receiving power; MimioStudio software is not running.

About MimioStudio View

The View window displays the image captured by the MimioView camera. From the View window, you can rotate or zoom the image, mark up the image using MimioStudio Tools, adjust the contrast and brightness settings, freeze the image, and so on.

The following figure shows the major features of the MimioStudio View window.

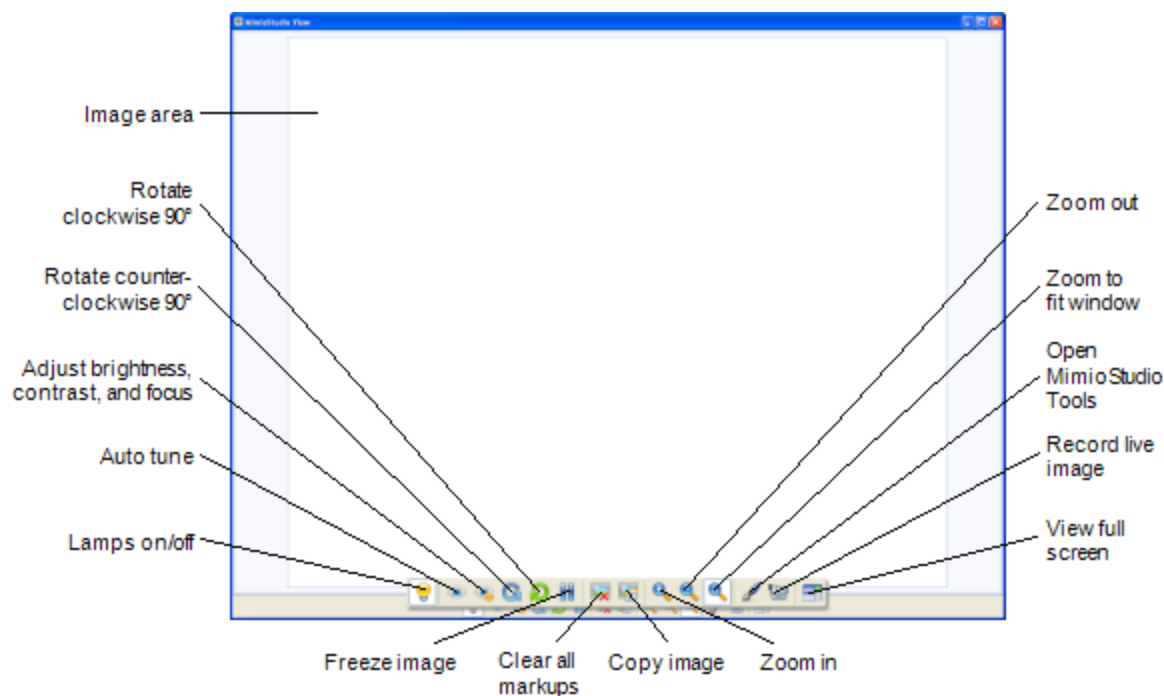

Getting Started

Review the following topics to install and start using MimioView.

- Installing MimioView
- Opening the View Window
- Closing the View Window

Installing MimioView

Once you have installed the MimioStudio software on your computer, you can quickly install MimioView.

To install MimioView

1. Remove the protective covering from the MimioView camera lens.

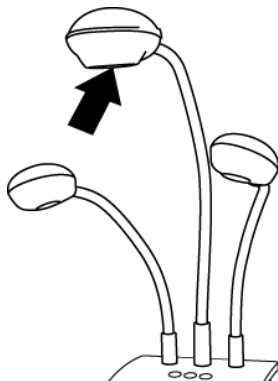

2. Plug the USB cable into the Micro-B USB port on the back of the camera base.

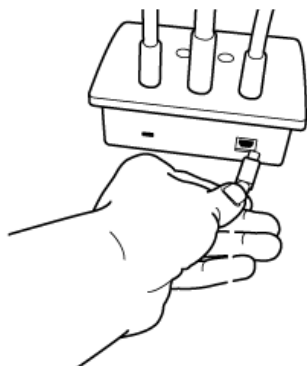

3. Connect the other end of the USB cable into an available USB port on your computer.

Opening the View Window

When you press the View button on the MimioView, the camera and lamps turn on and the MimioStudio View window opens automatically.

To open the View window

- ▶ Press  on the MimioView base.
The MimioStudio View window opens and the camera and lamps turn on.

Closing the View Window

You can close the MimioStudio View window from the View window or directly from the MimioView camera.

To close the View window

- ▶ Do one of the following:
 - Close the MimioStudio View window.
The camera and lamps turn off automatically.
 - Press  on the camera base.
The camera and lamps turn off and the MimioStudio View window closes.

Using MimioView

You can use MimioView to display a still image or live video of documents, three-dimensional objects, or microscope slides. You can also use MimioStudio Tools to mark up the still image or live video displayed in the View window; you can then save the image to a Notebook or the Gallery for later use.

Displaying an Image

You can use MimioView to display a still image or live video of documents, three-dimensional objects, or microscope slides.

Displaying a Document

You can use MimioView to display a document, book, or other two-dimensional object.



To display a document

1. Place the document under the MimioView camera.
2. Adjust the camera head so that the desired image is displayed in the View window.
3. Adjust the lamps to light the document as desired.
4. Press  on the MimioView base.

Displaying an Object

Using MimioView, you can display a three-dimensional object. The camera and lamps are each attached to the MimioView base by a flexible, gooseneck. This allows you to precisely position the camera and lamps for the best possible view of the object you are displaying.

To display a three-dimensional object

1. Place the object under the MimioView camera.
2. Adjust the camera head so that the desired image is displayed in the View window.
3. (Optional) Press  to rotate the image to the desired orientation.
4. Adjust the lamps to light the object as desired.
5. Press  on the MimioView base.

Displaying a Microscope Slide

Using the included microscope adapter, you can display an image from a microscope with the MimioView camera.

 The microscope adapter can be used with a 28 mm microscope eyepiece.

To display a microscope slide

1. Set up the microscope so that you have the desired view through the microscope eyepiece.
2. Twist and lock the microscope adapter onto the MimioView camera head.
3. Slowly and carefully slide the other end of the microscope adapter onto the microscope eyepiece.

 Use caution to make sure that the image stays in focus while attaching the microscope adapter.

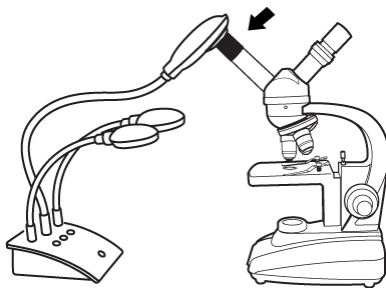

The image from the microscope is displayed in the View window.



4. Make any adjustments necessary to the microscope to adjust the image.
5. Press  on the MimioView base.

Freezing the Image

The image captured by the MimioView camera is displayed in the View window. By default, a live image is displayed. However, you can choose to display a still image of the

object.

To freeze the image

- ▶ Do one of the following:
 - Press  on the MimioView base.
 - Click  on the View toolbar.

The image is paused in the View window.

- 💡 To return to displaying live video, press  or click  a second time.

Adjusting the Image

MimioView includes features that make it easy to adjust the image displayed in the MimioStudio View window without having to adjust the camera or the displayed object.

You can do the following to adjust the displayed image:

- Rotate the Image
- Zoom the Image
- Adjust the Settings



Rotating the Image

You can quickly rotate the image that is displayed in the View window directly from the MimioView camera or from the View window.

To rotate an image from the MimioView camera

- ▶ Press  on the MimioView.
The image displayed in the View window rotates clockwise 90 degrees.

To rotate an image from the View window



- ▶ Do one of the following:
 - To rotate the image clockwise, click .
 - To rotate the image counter-clockwise, click .
- The image displayed in the View window rotates 90 degrees in the selected direction.

Zooming the Image

You can quickly zoom the image displayed in the View window.

- 💡 You can also zoom the image displayed in the View window using the Zoom tool in MimioStudio Tools.

To zoom the image



- ▶ Do one of the following:
 - To zoom in on the image, click  on the toolbar.
 - To zoom out on the image, click  on the toolbar.
 - To fit the image to the MimioStudio View window, click  on the toolbar.

- 💡 If the area of the image that you want to display is not visible in the View window, use the scroll bars to display the desired area of the image.



Adjusting the Settings

You can adjust the brightness and contrast settings automatically or manually.

To adjust the settings automatically

- Do one of the following:
 - Press  on the MimioView base.
 - Click  on the View toolbar.

To adjust the settings manually

1. Click  on the View toolbar.
The Advanced Settings toolbar appears.
2. Move the Brightness and Contrast sliders to the right or left to adjust the settings as desired.
3. Click  to hide the Advanced Settings toolbar.

Annotating an Image

You can use MimioStudio Tools to annotate the image displayed in the View window. All object, drawing, and manipulation features in MimioStudio Tools are available to use in the View window.

 You can also add objects to the View window from MimioStudio Gallery.

See Adding Objects with MimioStudio Tools for information about using MimioStudio Tools.

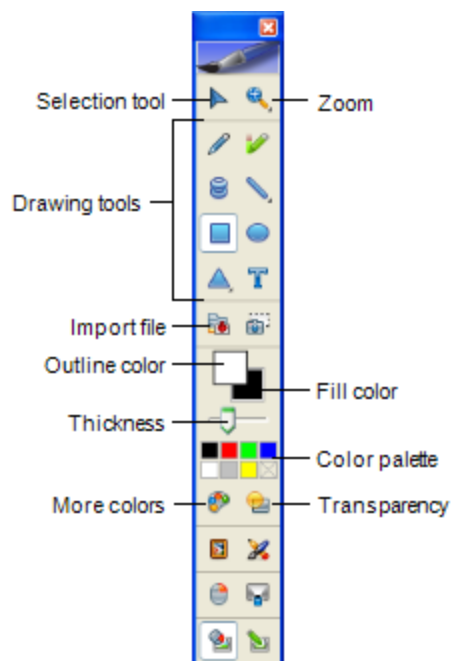

Clearing All Annotations from the Image

You can quickly clear all annotations from the View window.

To clear all annotations

- ▶ Click  on the View toolbar.
All annotations, including any added objects, are cleared from the View window.

Transferring an Image

You can transfer all or part of an image from the View window to a Notebook page, the Gallery, or another application.

To transfer an image

1. Click  on the View toolbar.
The Image area is displayed with a transparent mask.
2. Drag the cursor to draw a selection box around the area to copy.
The selected area is saved as an image to the clipboard.
3. Paste the image into the desired application.



Recording Video

Using MimioStudio Recorder, you can record your interactions into an AVI movie file, with or without audio. See Using MimioStudio Recorder for more information on how to use MimioStudio Recorder.

Turning Off the Lamps

When you turn on MimioView, the camera and both lamps turn on. However, you can choose to turn off the lamps and use the camera without the lamps.

To turn off the lamps

- Click  on the View toolbar.
-  To turn the lamps on again, click  a second time.

Caring For MimioView

Review the following topics for information about cleaning, storing, and mounting your MimioView.

- Cleaning MimioView
- Mounting MimioView Permanently

Cleaning MimioView

The MimioView is designed to give you long and trouble-free service, while requiring very little maintenance.

You can easily clean your MimioView using the following items:

- Lint-free cloth.
- Isopropyl alcohol, diluted dishwashing detergent, or diluted glass cleaner.
 If you use glass cleaner, make sure it does not contain ammonia.

To clean the exterior of the MimioView

1. Disconnect the USB cable.
2. Use the lint-free cloth to wipe the exterior of the MimioView.

3. Remove dirt and smudges with one of the cleaning solutions mentioned above.
⚠ Do not allow liquid into any openings on the equipment.
4. Reconnect the USB cable.

To clean the camera lens

- ▶ Use a clean, dry, lint-free cloth to gently wipe the surface of the lens.

Mounting MimioView Permanently

You can permanently mount your MimioView to a table or desk top using a standard VESA mount and four screws (size M4).

To mount MimioView permanently

1. Attach the VESA mount to the table or desktop.
For information about attaching the VESA mount to your table or desktop, see the VESA documentation.
2. Attach the VESA base to the bottom of the MimioView as shown.

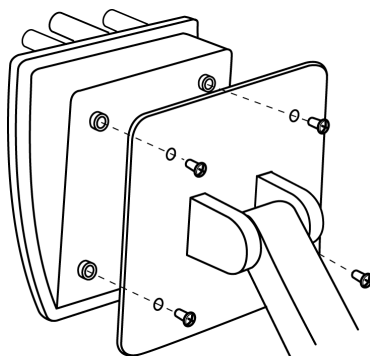

This page intentionally left blank for double-sided printing.

MimioStudio Recorder





MimioStudio Recorder can capture a live desktop, synchronized with audio, as a video file. You can save the file in two formats: Mimio and Microsoft. Both are AVI files, however, the Mimio format can only be played back using Mimio software. The Microsoft formatted AVI file can be played back in most Windows media players.

To import a video file you have already created elsewhere into MimioStudio Notebook, see Customizing the Content of the Gallery and Importing Gallery Items into a MimioStudio Notebook.

Using MimioStudio Recorder

MimioStudio Recorder allows you to record your mimio interactions as an AVI movie file with the option to record audio as well.

The following table shows several ways to access MimioStudio Recorder.



To start from	Do this
Taskbar	Right-click  , and then choose  Recorder .
Start Menu	Point to Programs, MimioStudio, Tools , and then choose MimioStudio Recorder .
MimioStudio Tools	Click the Applications button,  , and then choose  Recorder .



Recording a Presentation

MimioStudio Recorder can be used to easily record presentations using the standard record, pause, stop, and play features.

To start recording

1. Start MimioStudio Recorder.
2. Click the arrow to the right of the **Record** button, , and then choose a recording option from the list.

Option	Description
 Record Desktop	Records the entire desktop. (Default)
 Record Window	Records a specific window.
 Record Area	Records a selected area of the screen.

3. Just before you start your presentation, click the **Record** button, 
 - If you chose **Record Window**, select the window to record.
 - If you chose **Record Area**, drag a selection box around the area to record.
-  While recording, MimioStudio Recorder automatically minimizes and is displayed in the notification area of the taskbar as the MimioStudio Recorder icon, .



To pause recording

- ▶ Click  in the notification area of the taskbar.
This pauses the recording and opens the MimioStudio Recorder window.

To resume recording

- ▶ Click the **Record** button, .

To stop recording

1. Click  in the notification area of the taskbar.
This pauses the recording and opens the MimioStudio Recorder window.
2. Click the **Stop** button, .

To preview a recording

- ▶ Click the **Play** button, .
- Your default media player is started and your recording plays automatically.

-  Close your media player before starting a new recording.

To save a recording

1. Choose  **Save** from the **File** menu.
2. From the **Save As** dialog box, enter a name for the file in the **File name** box.
3. Click **Save**.

Sharing the Whiteboard Remotely

This chapter describes how to share a presentation displayed on a MimioTeach-enabled whiteboard with Microsoft NetMeeting®. You can also share your desktop using various other desktop sharing solutions such as Windows® Meeting Space.

Setting up MimioStudio with NetMeeting

MimioStudio is capable of automatically connecting your whiteboard to an open NetMeeting session. MimioStudio and NetMeeting can be used together in both Interactive and Recording modes.

To use NetMeeting interactively

1. Start the NetMeeting application.
Consult the Microsoft NetMeeting documentation if necessary.
2. Start MimioStudio in Interactive mode.
See Setting Up Interactive Mode.
3. Use the MimioTeach stylus to select tools and add content directly onto the NetMeeting Whiteboard.

To use NetMeeting with MimioCapture

1. Start the NetMeeting application and the NetMeeting Whiteboard.
Consult the Microsoft NetMeeting documentation if necessary.
2. Use the MimioCapture pens and eraser on the MimioTeach-enabled whiteboard.
Your content is shared on the NetMeeting Whiteboard.

Adjusting the NetMeeting Settings

The NetMeeting settings allow you to enable/disable Microsoft NetMeeting support and adjust the device associated with the NetMeeting Whiteboard.

To access the NetMeeting Settings

1. Start MimioStudio Settings.
2. Click  NetMeeting.

To enable NetMeeting interaction

- ▶ Select the **Enable NetMeeting interaction** check box.

To disable NetMeeting interaction

- ▶ Clear the **Enable NetMeeting interaction** check box.





To set up NetMeeting support for a specific MimioClassroom device

- ▶ Choose the device that you want to use with NetMeeting from the **Device** list.

Customizing MimioStudio

This chapter describes the general features of MimioStudio Settings.

The following table shows several ways to access MimioStudio Settings.

To start from	Do this
Taskbar	Right-click  , and then choose  Settings .
MimioStudio Notebook	Do one of the following: <ul style="list-style-type: none">▪ Double-click  on the status bar.▪ Choose  Settings from the Tools menu.

MimioStudio Settings contains options for setting and customizing the properties and characteristics of your MimioClassroom system, including Classroom Devices, Ink Capture, Interactive, Language, NetMeeting, Notebook, Recorder, and Vote.

To change the settings

1. From the **MimioStudio Settings** dialog box, select the setting you want to change from the list on the left.
2. Make the changes you want to the settings.
 -  See later sections in this chapter for a complete description of all settings.
2. If you are unable to solve a problem, this chapter also describes how to contact DYMO Technical Support.
3. Click **Apply**.

Adjusting the Classroom Devices Settings

The Classroom Devices settings displays a list of all MimioClassroom devices that are connected or are available to connect to your computer. You can connect to any available devices using the Classroom Devices settings.

To connect to an available MimioClassroom device

1. Select the device to connect to from the **Devices** list.
2. Click **Connect**.

Adjusting the Ink Capture Settings

The Ink Capture settings allow you to do the following:

- Change the surface size for a connected MimioTeach device
- Change the width and color assignment for each MimioCapture pen

- Create a combined surface using two or more MimioTeach devices and two or more MimioCapture devices

 You can combine up to four different surfaces.

These settings are only used when your MimioTeach device is used to capture digital ink.

To adjust the settings for a MimioTeach device

1. Choose the device to adjust from the **Device** list.
2. Make the changes you want to the settings.
3. Click **Apply**.

To adjust surface size for a MimioTeach device

- ▶ Do one of the following:
 - Choose a size from the **Surface Size** list.
 - Choose **Custom** from the **Surface Size** list and enter the desired values into the **Width** and **Height** boxes.
 - Click **Auto Size** and touch a MimioCapture pen at the location shown in the **Auto Size** dialog box.

To adjust the pen settings

1. Click **Pens**.
The Pens dialog box appears.
2. Choose the MimioCapture pen to adjust from the **Pen** list.
3. To adjust the line thickness of the pen, drag the **Pen Width** slider.
Alternately, enter a value into the **Pen Width** box.
4. To adjust the pen color, select a color from the **Pen Color** palette.
For additional color choices, click **More Colors**.
5. Click **OK**.

To create a combined surface

1. Connect two or more MimioTeach devices and two or more MimioCapture devices to your computer.
2. Set the surface size for each MimioTeach device.
3. Click **Combine**.
The Create extended surface dialog box appears.
4. Choose the arrangement of your combined surfaces from the **Extend Surface Styles** list.
5. Press the **New Page** button, , on each MimioCapture tray, in the order shown.
6. Enter a name for your extended surface in the **Extend Surface Name** box and click **OK**.

 You can combine up to four different surfaces.

To view device information

- ▶ Click **Settings**.
The dialog box appears showing the device information, environmental analysis, and device memory.

To reset to the default device settings

- ▶ Click **Defaults**.

Adjusting the Interactive Settings

The Interactive settings allow you to calibrate or enable (if calibration has already been done) Interactive mode. The Interactive settings also contain settings for changing the functions of the MimioTeach stylus, MimioTeach bar, and MimioCapture tray buttons.

General Settings

Setting	Description
Use previous calibration	Prevents you from having to calibrate each time you start Interactive mode. Select this setting if you have a permanently installed whiteboard and projector.
Automatically enable when a device is detected	Automatically starts Interactive mode when a MimioTeach bar is connected to your computer.

Actions and Commands Settings

Setting	Description
Action	List of the MimioTeach stylus, MimioTeach bar, and MimioCapture tray buttons.
Function	List of the functions that you can associate with a MimioTeach stylus, MimioTeach bar, or MimioCapture tray button.

Adjusting the Language Settings

You can change the display language for MimioStudio software so that you can work in a language that is most familiar to you.

To adjust the language

1. Choose a language from the **Language** list.
2. Click **Apply**.
The MimioStudio dialog box appears.
3. Click **Yes** to restart MimioStudio in the selected language.

Adjusting MimioStudio Notebook Settings

MimioStudio Notebook settings provides options for setting the general parameters of MimioStudio and the default interaction mode with MimioClassroom devices.

The following tables describe the MimioStudio Notebook settings.

General Settings

Setting	Description
Enable audio feedback	Enables sound from a mimio device when buttons are pressed or the device is connected or disconnected from the computer.
Enable smooth ink, objects and text	Enables smooth or anti-aliased ink, objects, and text. Disabling this setting can increase the performance of the application.
Enable auto recovery	Enables the automatic recovery of data if MimioStudio quits unexpectedly. When this setting is enabled, MimioStudio Notebook saves ink data to a backup file every 10 minutes.
Enable trashcan	Places the trashcan on the MimioStudio Notebook as an easy method for deleting content.
Enable fullscreen border (Screen Annotation only)	Enables the border during Screen Annotation mode. See Marking Up the Display Using Screen Annotations.

Ink Capture Settings

Setting	Description
Connect to available device on file new	Automatically connect devices to newly opened Notebook.
Connect to device when any pen is used	Automatically open a Notebook in Ink Capture mode when a MimioCapture pen touches the whiteboard.

Adjusting MimioStudio Recorder Settings

The MimioStudio Recorder settings allow you to adjust the video and audio quality used for recording sessions.

The following table describes the MimioStudio Recorder settings.

Setting	Description
Video Quality	Choose the quality to use to record video.
Audio Quality	Choose the quality to use to record audio.
Video Format	Choose the format for recording a movie.

Adjusting the Vote Settings

The following table describes the MimioStudio Vote settings.

Setting	Description
Buttons	Select to have each MimioVote unit button illuminated with a different color or to have all the buttons illuminated with a single color.
Display student scores on handheld units	Select this check box to have the student score displayed on each student's MimioVote unit once the student has completed a self-paced activity.
Store screen snapshot with question	Select this check box to save a screen shot with each question polled using MimioStudio Quick Vote.

This page intentionally left blank for double-sided printing.

Chapter 10

Getting Help

This chapter describes how to check for and install software updates, and how to troubleshoot some common problems.

If you are unable to solve a problem, this chapter also describes how to contact DYMO Technical Support.

Updating the Software

The Software Update settings allow you to check for and install MimioStudio software updates.

You must be connected to the Internet to check for updates.

To check for software updates

1. Start MimioStudio Settings.
2. Select  **Software Update**.
3. Click **Check for Updates**.

A list of available updates is displayed.

To turn on automatic update notification

- ▶ Select the **Notify me when updates are available** check box, and then click **OK**.

To install software updates

1. Select the updates you want to install.
2. Click **Install**.

Troubleshooting

To test for environmental interference

1. Start MimioStudio Settings.
2. Select  **Ink Capture**, and then click **Settings**.
3. Under **Environmental Analysis**, click **Test**.

Contacting DYMO

DYMO maintains an Internet Web site that offers support for MimioClassroom products.

Web site: www.mimio.dymo.com

This page intentionally left blank for double-sided printing.

Chapter 11

Technical and Environmental Information

This chapter contains technical and certification information for the MimioClassroom products.

Technical Specifications

MimioView

Output Resolution	UXGA (1600 X 1200)
Sensor Pixel	2M Micron
Input/Output	USB 2.0 High Speed only
Zoom	4.8x mechanical zoom, 16x digital zoom
Shooting Area	420 mm x 315 mm when height is 360 mm (16.5 in x 12.4 in)
Driver Interface	UVC
Image Rotation	90 degree increments (CW/CCW)
Macro	Microscope adapter
Overall Weight	1.25 kg (2.8 lb)
Footprint Dimensions	12.7 cm x 14 cm (5.0 in x 5.5 in)
Operating Temperature	16° C - 27° C (60° F - 80° F)
Storage Temperature	-20° C - 55° C (-4° F - 131° F)

Declaration of Conformity

Supplier Name: Newell Rubbermaid Inc.
Supplier Address: Charles Park - 3rd Floor
Cambridge, MA 02142
USA

United States and Canada

MimioTeach, MimioCapture, and MimioVote

These devices comply with Part 15 of the FCC Rules. Operation is subject to the following two conditions:

- (1) this device may not cause harmful interference.
- (2) this device must accept any interference received, including interference that may cause undesired operation.

This equipment has been tested and found to comply with the limits for a Class A digital device, pursuant to Part 15 of the FCC (Federal Communications Committee) rules. These limits are designed to provide reasonable protection against harmful interference when the equipment is operated in a commercial environment. This equipment generates, uses, and can radiate radio frequency energy, and, if not installed and used in accordance with the instructions, may cause harmful interference to radio communications. Operation of this equipment in a residential environment is likely to cause harmful interference in which case the user will be required to correct the interference at his own expense.

There is no guarantee that interference will not occur in a particular installation. If this equipment does cause harmful interference to radio or television reception, which can be determined by turning the equipment off and on, the user is encouraged to try correcting the interference by one or more of the following measures:

- Reorient the receiving antenna.
- Increase the separation between the equipment and the receiver.
- Connect the equipment to an outlet on a circuit different from that to which the receiver is connected.
- Use shielded cables to connect this device to computers.
- Consult the dealer or an experienced radio/TV technician for help.

You may find helpful the following booklet, prepared by the FCC: Interference Handbook. This booklet is available from the U.S. Government Printing Office, Superintendent of Documents, Washington, DC 20402-9325.

This Class A digital apparatus complies with Canadian ICES-003.

Cet appareil numérique de la classe A est conforme à la norme NMB-003 du Canada.

NOTE: Changes or modifications to this unit not expressly approved by the party responsible for compliance could void the user's authority to operate the equipment and void the manufacturer's warranty.

MimioView

This device complies with Part 15 of the FCC Rules. Operation is subject to the following two conditions:

- (1) this device may not cause harmful interference.
- (2) this device must accept any interference received, including interference that may cause undesired operation.

This equipment has been tested and found to comply with the limits for a Class B digital device, pursuant to Part 15 of the FCC (Federal Communications Committee) rules. These limits are designed to provide reasonable protection against harmful interference when the equipment is operated in a residential environment. This equipment generates, uses, and can radiate radio frequency energy, and, if not installed and used in accordance with the instructions, may cause harmful interference to radio communications.

There is no guarantee that interference will not occur in a particular installation. If this equipment does cause harmful interference to radio or television reception, which can be determined by turning the equipment off and on, the user is encouraged to try correcting the interference by one or more of the following measures:

- Reorient the receiving antenna.
- Increase the separation between the equipment and the receiver.
- Connect the equipment to an outlet on a circuit different from that to which the receiver is connected.
- Use shielded cables to connect this device to computers.
- Consult the dealer or an experienced radio/TV technician for help.

You may find helpful the following booklet, prepared by the FCC: Interference Handbook. This booklet is available from the U.S. Government Printing Office, Superintendent of Documents, Washington, DC 20402-9325.

This Class B digital apparatus complies with Canadian ICES-003.

Cet appareil numérique de la classe B est conforme à la norme NMB-003 du Canada.

NOTE: Changes or modifications to this unit not expressly approved by the party responsible for compliance could void the user's authority to operate the equipment and void the manufacturer's warranty.

European Union

MimioTeach

Newell Rubbermaid Inc. declares under sole responsibility that this product conforms to the following European Normative and/or International Standards:

EN 55022:2006 w/ A1:2007	Electromagnetic Interference
EN 55024:1998 w/ A1:2001 & A2:2003	Electromagnetic Immunity
EN 60950-1:2006 2nd Ed.	Product Safety
EN 300 328 v1.7.1 EMC/ERM:	Wideband Transmission
EN 301 489-1 v1.7.1 EMC / ERM:	Common Technical Reqs
EN 301 489-17 v1.8.1 EMC/ERM:	2.4 GHz WB Transmission

Following the provisions of the Normative European Council Directives:

EMC Directive	EMC Directive
Low Voltage Directive	2006/95/EC
R&TTE Directive	1999/5/EC

This is a Class A product. In a domestic environment this product may cause radio interference in which case the user may be required to take adequate measures.

MimioCapture

Newell Rubbermaid Inc. declares under sole responsibility that this product conforms to the following European Normative and/or International Standards:

EN 55022:2006 w/ A1:2007	Electromagnetic Interference
EN 55024:1998 w/ A1:2001 & A2:2003	Electromagnetic Immunity
EN 60950-1:2006 2nd Ed.	Product Safety

Following the provisions of the Normative European Council Directives:

EMC Directive	EMC Directive
Low Voltage Directive	2006/95/EC

This is a Class A product. In a domestic environment this product may cause radio interference in which case the user may be required to take adequate measures.

MimioVote

Newell Rubbermaid Inc. declares under sole responsibility that this product conforms to the following European Normative and/or International Standards:

EN 55022:2006 w/ A1:2007	Electromagnetic Interference
EN 55024:1998 w/ A1:2001 & A2:2003	Electromagnetic Immunity
EN 60950-1:2006 2nd Ed.	Product Safety
EN 300 328 v1.7.1 EMC/ERM:	Wideband Transmission
EN 301 489-1 v1.7.1 EMC / ERM:	Common Technical Reqs
EN 301 489-17 v1.8.1 EMC/ERM:	2.4 GHz WB Transmission

Following the provisions of the Normative European Council Directives:

EMC Directive	EMC Directive
Low Voltage Directive	2006/95/EC
R&TTE Directive	1999/5/EC

This is a Class A product. In a domestic environment this product may cause radio interference in which case the user may be required to take adequate measures.

MimioView

Newell Rubbermaid Inc. declares under sole responsibility that this product conforms to the following European Normative and/or International Standards:

EN 55022:2006 w/ A1:2007	Electromagnetic Interference
EN 55024:1998 w/ A1:2001 & A2:2003	Electromagnetic Immunity
EN 60950-1:2006 2nd Ed.	Product Safety

Following the provisions of the Normative European Council Directives:

EMC Directive	EMC Directive
Low Voltage Directive	2006/95/EC

Environmental Information

The equipment that you bought has required the extraction and use of natural resources for its production. It may contain hazardous substances for the health and the environment.

In order to avoid the dissemination of those substances in our environment and to diminish the pressure on the natural resources, we encourage you to use the appropriate take-back systems.

Those systems will reuse or recycle most of the materials of your end life equipment in a sound way.

The crossed-bin symbol marked in your device invites you to use those systems.



If you need more information on the collection, reuse and recycling systems, please contact your local or regional waste administration.

You can also contact DYMO for more information on the environmental performances of our products.

Safety Precautions for Lithium-Ion Rechargeable Batteries

Inaccurate handling of a Lithium-ion rechargeable battery may cause leakage, heat, smoke, an explosion, or fire. This could cause deterioration of performance or failure. This may also damage the protection device installed in the battery pack. This could damage equipment or injure users. Thoroughly follow the instructions below.

While Charging



Danger

- When charging the battery, use dedicated chargers and follow the specified conditions.
- Do not connect directly to an electric outlet or cigarette lighter charger.
- Do not use or store battery close to fire or inside the car where temperature may be over 60°C.



Warning

- Stop charging the battery if charging is not completed within the specified time.



Caution

- Thoroughly read this user guide before charging the battery.
- Do not charge in a place that generates static electricity.
- Battery can only be charged within 0°C~45°C temperature range.

When Discharging the Battery



Danger

- Use the battery only in the specified equipment.
- Do not use or store battery close to fire or inside the car where temperature may be over 60°C.



Caution

- Do not charge in a place that generates static electricity.
- Battery can only be used within -20°C~60°C temperature range.

Documentation Feedback

We are constantly working to produce the highest quality documentation for our products. We welcome your feedback. Send us your comments or suggestions about our online Help, printed, or PDF manuals.

Please include the following information with your feedback:

- Product name and version number
- Type of document: printed manual, PDF, or online Help
- Topic title (for online Help) or page number (for printed or PDF manuals)
- Brief description of content (for example, step-by-step instructions that are inaccurate, information that requires clarification, areas where more detail is needed, and so on)
- Suggestions for how to correct or improve the documentation

We also welcome your suggestions for additional topics you would like to see covered in the documentation.

Send email feedback to:

documentation@dymo.com

Please keep in mind that this email address is only for documentation feedback. If you have a technical question, please contact Customer Service.

This page intentionally left blank for double-sided printing.